

# A Practical Guide to Fire Alarm Systems

Provided as a service to the insurance  
industry and fire protection  
community by the Central Station  
Alarm Association

**Third Edition**

**Central Station Alarm Association**  
8150 Leesburg Pike  
Suite 700  
Vienna, VA 22182

703.242.4670 Voice

703.242.4675 Fax

admin@csaintl.org Email

www.csaintl.org Website

**The Association of the Professional Monitoring Industry**



A  
Practical Guide  
to  
Fire Alarm Systems  
(Third Edition)

All rights reserved.

No part of this publication can be reproduced or transmitted in any form, or by any means, including photocopying and recording, without the written permission of the Central Station Alarm Association. Written permission also is required if this publication is stored in a retrieval system of any nature.

This guide contains references to copyrighted standards published by several nationally recognized testing laboratories. In each case, the copyright and any associated trademarks are the property of the respective organization.

While the advice contained in this guide is based on information supplied by recognized fire and fire protection experts, no guide can provide total assurance that a home or business will be completely safe from fire. The membership of the Central Station Alarm Association has experts on staff to help in designing the proper fire alarm protection.

Copyright 2011, Central Station Alarm Association

v.1.0

---

# Acknowledgements

This third edition of A Practical Guide to Fire Alarm Systems is the first electronic version of the guide. The guide is a collaborative effort of many, but particular thanks must go to Dr. Shane M. Clary of Bay Alarm Company in Pacheco, California, whose outstanding and detailed review and comments were instrumental in the production of the guide. Additional thanks go to Lou Fiore, of L.T. Fiore, Inc., and Peter Tallman of Underwriters Laboratories, for their review and comments. The guide was graphically designed by Jay Tribich of DGA Security Systems, Inc. in New York.

The guide is a living document and all comments and suggestions are welcome and encouraged.

Stanley Oppenheim  
*Committee Chairman*  
DGA Security Systems, Inc.

New York, NY  
July 2011

---

# Table of Contents

6	<b>About the Central Station Alarm Association</b>
7	<b>Basic Fire Alarm Systems Overview</b>
13	<b>1. Selecting a Fire Alarm System for your Application</b> Life Safety Property Protection Mission Protection Heritage Protection Application Guidelines
19	<b>2. Basic Fire Alarm Systems</b> Fire Alarm System Components Alarm Initiating Devices Notification Appliances Fire Alarm Control Units (Panels) Remote Annunciators Battery Standby Power Fire Safety Control Functions Fire Alarm System Wiring Types of Fire Alarm Systems Protected Premises Emergency Voice / Alarm Communication Central Station Proprietary Remote Station Auxiliary Systems The Building Codes and Listed Central Station Service
38	<b>3. Fire Alarm Transmission Systems</b>
40	<b>4. Equipment and Trained Personnel</b>

41	<b>5. The Fire Alarm Certificate Service of Underwriters Laboratories Inc.</b> About Underwriters Laboratories Background Certificates Inspections Listings Required Services UL Certificate Verification Service (ULCVS) Benefits of ULCVS Certificate Reports UL Procedures for Issuing Alarm Certificates
46	<b>6. Factory Mutual Research Corporation (FMRC) Approval Process</b> About Factory Mutual Research Corporation (FMRC) Factory Mutual Approval Guide Factory Mutual Central Station Approval Factory Mutual Protective Signaling Service – Local Companies
49	<b>7. ETL Listed Alarm System Certification Program</b> About Intertek Background Certificates Inspections Intertek’s Alarm Service Company Database, My Test Central Additional Information
51	<b>8 Residential Fire Alarm Systems</b>
53	<b>9. Fire Detection to Comply with Insurance Requirements</b>
55	<b>10. Highly Protected Risks (HPR) Fire Protection and Surveillance</b>
57	<b>11. Special Appliance for Fire Protection</b> Combination Systems Special Hazard Systems Automatic Sprinkler Systems Interface with Fire Alarm Systems
59	<b>12. Maintaining Fire Alarm System Reliability</b> Fire Alarm System Reliability Testing Requirements
63	<b>References</b>
64	<b>Appendix: Glossary of Terms</b>

---

# About the Central Station Alarm Association

The Central Station Alarm Association (CSAA) is the national nonprofit trade organization for individuals or companies whose primary business is the operation of central station facilities. Its purpose, from its founding in 1950 to the present, has been to foster and improve relationships among providers and users of NRTL Listed and Approved central station protective services, and with agencies that have jurisdiction over, or regulate such services.

CSAA was incorporated on November 30, 1950 in the State of Illinois as the Central Station Electrical Protection Association. According to the original Articles of Incorporation, the stated purpose of the Association was “to foster and improve relations between users and sellers of burglar and fire alarm equipment and between bureaus and other bodies and agencies having jurisdiction over or regulating the Central Station Electrical Protection Services industry.”

Today, the purpose of the CSAA, as stated in its bylaws, is: “To foster and maintain relationship among providers, users, bureaus, and other agencies of NRTL Approved Central Station protection services, and to promote the mutual interests of the NRTL Approved Central Station alarm industry with public officials, the insurance industry and our customers.” As the Association continues to expand, there is little doubt that its mission will also continue to evolve and grow.

In addition, CSAA recognizes other goals essential to the well being of its members, including, but not limited to:

- Working with law enforcement, fire and insurance industry officials;
- Working with and serving on National Fire Protection Association committees;
- Resolving unwanted alarms;
- Involving CSAA with the Alarm Industry Communications Committee (AICC), which has been serving member needs for more than 30 years. Composed of members of major companies and allied organizations, AICC lobbies Congress and the FCC on behalf of members’ interests;
- Developing industry-driven standards to determine a level of performance for professional Central Stations;
- Investigating, involving itself with, and reporting on potential future technologies; and
- Conducting annual meetings, seminars, legislative conferences and other gatherings of benefit to the industry.

---

# Basic Fire Alarm Systems Overview

This Guide was commissioned by the Central Station Alarm Association to enable those who come in contact with fire alarm systems to have a better understanding of how these systems work. This edition has been updated to reflect Code changes and includes additional information to assist the reader in a better understanding of the part Central Station connected fire alarm systems play in meeting the Life Safety Protection, Property Protection, Mission Protection and Heritage Preservation fire protection goals of the owner. Since the second edition of this publication, there have been three editions of NFPA 72® published. These are the 2002, 2007 and the 2010 editions. This guide is not meant to replace knowledge of various code and standards, but is meant as a guide to give the reader an overview.

What constitutes a useful and reliable fire alarm system? Generally a fire alarm system is installed for protection of life, property and mission. In order for a fire alarm system to be useful, it must be able to perform these functions:

1. Detect the presence of a fire.
2. Notify the occupants
3. Notify the fire department (usually through a central station connection)
4. Operate other fire safety functions, e.g., release magnetically held open smoke doors.

Heat and smoke detectors are the most commonly used fire detection devices. Heat detectors are designed to detect a fixed amount of heat present at the detector or a rapid increase of heat in the area of the detector. Smoke detectors can detect the presence of smoke in an area (when it reached the ceiling where the detector is normally located.) There are two common types of smoke detectors, ionization and photoelectric. Care should be taken in selecting the type of detector to be used. Ion detectors will detect a flaming fire faster, but a photo electric detector will detect a smoldering fire quicker in most situations. Manual fire alarm boxes are usually placed (as a minimum) at all exits on each floor in a building. If an automatic sprinkler system is present in a building, waterflow devices are used to indicate that system's operation. More detailed information on all of these devices is covered in later sections of this Guide.

In order for the automatic detection devices, such as heat and smoke detectors, to provide the intended protection, care must be taken in



Duct Detector



Smoke Detector



Notification Appliances



Door Release



Central Station Transmitter



Elevator Recall



Heat Detector



Manual Pull Station

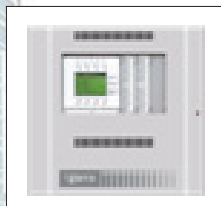

Fire Control Panel



Waterflow Switch

Typical Fire Alarm System

selecting the level of coverage to be used. A common misconception is that “strategically” placing a few smoke or heat detectors in a particular area of a building (such as smoke detectors in an apartment building hallway) provides good “early warning protection.” It should be obvious that if the fire is remote from the detector location, the fire will not be detected “early.” Most individuals involved in fire protection would not consider a few automatic sprinklers placed in a building “complete sprinkler coverage.” But, these same individuals seem to think partial coverage of a building with automatic fire detectors will meet the goals of life safety and property protection. The fact is that a detector of any type cannot detect a fire (in a reasonable amount of time) unless it is intimate with the fire. So in order to effectively detect the presence of a fire, total coverage using smoke and heat detectors should be provided. In some cases where property protection or mission protection is the goal, the owner may choose to install a complete automatic sprinkler system. This system would then be monitored by the fire alarm system to ensure its operational integrity.

Notifying the occupants is usually accomplished by producing enough sound to attract their attention and indicate that emergency evacuation is necessary. Horns, bells, sirens, stroboscopic lights and speakers are the most common appliances used to provide this notification. These appliances are as important as the detection portion of the fire alarm system. A number of notification appliances (horns, bells, etc.) must be strategically placed throughout the building to provide the amount of noise needed to get everyone’s attention while they occupy their normal environment.

Automatically notifying the fire department, as early as possible, is extremely important to effectively reduce losses due to a fire. If the detection portion of the fire alarm system has been designed properly, the fire will be relatively small at detection. Early detection helps to give the fire department time to respond and then to control and suppress the fire. Ideally this should be the goal of any fire alarm system design. The most uniformly accepted method to reliably notify the fire department is through a connection to a Listed or Approved Central Station.

The National Fire Alarm and Signaling Code, NFPA 72 and the National Electrical Code, NFPA 70 govern the entire installation of a fire alarm system. The requirements found in these codes apply to all types of fire alarm systems. The importance of having a basic understanding of what makes up a typical fire alarm system cannot be overemphasized. It is as equally important to be familiar with the applicable codes and standards governing fire alarm system applications and installations, as it is to understand how the system functions. More detailed information regarding fire alarm system operation is contained in the remaining sections of this Guide.

All systems must comply with the requirements of NFPA 72. The current edition of NFPA 72 is the 2010 Edition renamed National Fire Alarm and Signaling Code. Jurisdictions have adopted various older editions of NFPA 72 into law. It is important to find out which edition is law in your location.

The 2010 Code consists of 29 Chapters. NFPA 72, as stated above is now called the National Fire Alarm and Signaling Code. The title change recognizes that NFPA 72 addresses signaling systems used for more than just fire hazards.

# NFPA 72® National Fire Alarm and Signaling Code – 2010 Edition

## **Chapter 1 Administration**

- 1.1 Scope
- 1.2 Purpose
- 1.3 Application
- 1.4 Retroactivity
- 1.5 Equivalency
- 1.6 Units and Formulas
- 1.7 Code Adoption Requirements

## **Chapter 2 Referenced Publications**

- 2.1 General
- 2.2 NFPA Publications
- 2.3 Other Publications
- 2.4 References for Extracts in Mandatory Sections

## **Chapter 3 Definitions**

- 3.1 General
- 3.2 NFPA Official Definitions
- 3.3 General Definitions

## **Chapter 4 Reserved**

## **Chapter 5 Reserved**

## **Chapter 6 Reserved**

## **Chapter 7 Reserved**

## **Chapter 8 Reserved**

## **Chapter 9 Reserved**

## **Chapter 10 Fundamentals**

- 10.1 Application
- 10.2 Purpose
- 10.3 Equipment
- 10.4 Personnel Qualifications
- 10.5 Power Supplies
- 10.6 Signal Priority
- 10.7 Distinctive Signals
- 10.8 ECS Priority Signals
- 10.9 Fire Alarm Signals
- 10.10 Fire Alarm Signal Deactivation
- 10.11 Supervisory Signals
- 10.12 Trouble Signals
- 10.13 Emergency Control Function Status Indicators.
- 10.14 Performance and Limitations
- 10.15 Protection of Fire Alarm System
- 10.16 Annunciation and Annunciation Zoning
- 10.17 Monitoring Integrity
- 10.18 Documentation
- 10.19 Impairments

## **Chapter 11 Reserved**

## **Chapter 12 Circuits and Pathways**

- 12.1 Application
- 12.2 General
- 12.3 Pathway Class Designations

- 12.4 Pathway Survivability

- 12.5 Nomenclature

## **Chapter 13 Reserved**

## **Chapter 14 Inspection, Testing, and Maintenance**

- 14.1 Application

- 14.2 General

- 14.3 Inspection

- 14.4 Testing

- 14.5 Maintenance

- 14.6 Records

## **Chapter 15 Reserved**

## **Chapter 16 Reserved**

## **Chapter 17 Initiating Devices**

- 17.1 Application

- 17.2 Purpose

- 17.3 Performance-Based Design

- 17.4 General Requirements

- 17.5 Requirements for Smoke and Heat Detectors

- 17.6 Heat-Sensing Fire Detectors

- 17.7 Smoke-Sensing Fire Detectors

- 17.8 Radiant Energy-Sensing Fire Detectors

- 17.9 Combination, Multi-Criteria, & Multi-Sensor Detectors

- 17.10 Gas Detection

- 17.11 Other Fire Detectors.

- 17.12 Sprinkler Waterflow Alarm-Initiating Devices

- 17.13 Detection of the Operation of Other Automatic Extinguishing Systems

- 17.14 Manually Actuated Alarm-Initiating Devices

- 17.15 Fire Extinguisher Electronic Monitoring Device

- 17.16 Supervisory Signal-Initiating Devices

## **Chapter 18 Notification Appliances**

- 18.1 Application

- 18.2 Purpose

- 18.3 General

- 18.4 Audible Characteristics

- 18.5 Visible Characteristics – Public Mode

- 18.6 Visible Characteristics – Private Mode

- 18.7 Supplementary Visible Signaling Method

- 18.8 Textual Audible Appliances

- 18.9 Textual Visible Appliances

- 18.10 Tactile Appliances

- 18.11 Standard Emergency Service Interface

## **Chapter 19 Reserved**

## **Chapter 20 Reserved**

## **Chapter 21 Emergency Control Functions and Interfaces**

- 21.1 Application

- 21.2 General

- 21.3 Elevator Recall for Fire Fighters' Service
- 21.4 Elevator Shutdown
- 21.5 First Responders Use Elevators
- 21.6 Elevators for Occupant-Controlled Evacuation.
- 21.7 Heating, Ventilating and Air-Conditioning (HVAC) Systems
- 21.8 Door Release Service
- 21.9 Electrically Locked Doors
- 21.10 Exit Marking Audible Notification Systems

**Chapter 22 Reserved**

**Chapter 23 Protected Premises Fire Alarm Systems**

- 23.1 Application
- 23.2 General
- 23.3 System Features
- 23.4 System Performance and Integrity
- 23.5 Performance of Initiating Device Circuits (IDCs)
- 23.6 Performance of Signaling Line Circuits (SLCs)
- 23.7 Performance of Notification Appliance Circuits (NACs)
- 23.8 System Requirements
- 23.9 In-Building Fire Emergency Voice/Alarm Communications
- 23.10 Prerecorded (Digital) Voice and Tone Fire Alarm Systems
- 23.11 Two-Way Communication Service
- 23.12 Signal Annunciation
- 23.13 Suppression System Actuation
- 23.14 Off-Premises Signals
- 23.15 Guard's Tour Supervisory Service
- 23.16 Suppressed (Exception Reporting) Signal System
- 23.17 Protected Premises Fire Safety Functions
- 23.18 Special Requirements for Low-Power Radio (Wireless) Systems

**Chapter 24 Emergency Communications Systems (ECS)**

- 24.1 Application
- 24.2 Purpose
- 24.3 General
- 24.4 One-Way Emergency Communications Systems
- 24.5 Two-Way, In-Building Emergency Communications Systems
- 24.6 Information, Command, and Control
- 24.7 Performance-Based Design of Mass Notification Systems

**Chapter 25 Reserved**

**Chapter 26 Supervising Station Alarm Systems**

- 26.1 Application
- 26.2 General
- 26.3 Alarm Systems for Central Station Service
- 26.4 Proprietary Supervising Station Systems
- 26.5 Remote Supervising Station Alarm Systems

- 26.6 Communications Methods for Supervising Station Alarm Systems

**Chapter 27 Public Emergency Alarm Reporting Systems**

- 27.1 Application
- 27.2 General Fundamentals
- 27.3 Management and Maintenance
- 27.4 Communications Methods
- 27.5 Alarm Processing Equipment
- 27.6 Alarm Boxes
- 27.7 Public Cable Plant
- 27.8 Emergency Communications Systems (ECS)

**Chapter 28 Reserved**

**Chapter 29 Single- and Multiple-Station Alarms and Household Fire Alarm Systems**

- 29.1 Application
- 29.2 Purpose
- 29.3 Basic Requirements
- 29.4 Assumptions
- 29.5 Detection and Notification
- 29.6 Power Supplies
- 29.7 Equipment Performance
- 29.8 Installation
- 29.9 Optional Functions
- 29.10 Maintenance and Tests
- 29.11 Markings and Instructions

**Annex A Explanatory Material**

**Annex B Engineering Guide for Automatic Fire Detector Spacing**

**Annex C System Performance and Design Guide**

**Annex D Speech Intelligibility**

**Annex E NEMA SB 30, Fire Service Annunciator and Interface**

**Annex F Sample Ordinance Adopting NFPA 72**

**Annex G Wiring Diagrams and Guide for Testing Fire Alarm Circuits**

**Annex H Informational References**

**Annex I Cross-Reference Table**

**Index**

Systems used for weather alerts and warnings, terrorist attacks, chemical releases and other threats are now directly incorporated in NFPA 72. In addition to the name change, there are structural changes aimed at making the Code easier to navigate and easier to grow in the future.

The preceding table shows the organization of the 2010 edition. Although chapters are numbered up to 29, there are only 14 being used in the 2010 edition. This allows for future changes and expansion without having to relocate existing text. These 14 chapters represent the 11 chapters of the 2007 edition plus three new chapters.

## Selecting a Fire Alarm System for your Application

Once the decision is made that a fire alarm system is to be installed in a property, whether the system is required by a code or not, you must determine what type of system and what type of equipment is needed. This determination should consider the specific building and fire codes in force in the jurisdiction as well as fire alarm system design meeting the application requirements. The selection of a fire alarm system should take into consideration the following:

- The purpose of the system
- The fire protection goals of the owner
- The type of occupancy to be protected
- The type and quantity of the contents to be protected
- The required response time of the system; i.e. how fast must it operate?
- The basic function of the system
- The applicable fire alarm system codes and standards
- The other fire protection systems that must be interfaced
- The response time of the fire department
- The available water supply

The purpose of the system is generally to notify the occupants and the fire department of a fire condition in the building. The system may also be used to actuate suppression systems or shut down equipment and manufacturing processes. The building and fire codes and the NFPA Life Safety Code® NFPA 101-2009 edition will provide the minimum fire alarm system requirements and guidance for the occupancy classification of the building.

A survey should be made to determine the type and quantity of the contents (also known as determining the fuel load) to ensure that the appropriate detectors are used for the application.

The owner must determine his or her fire protection goals and communicate that information to the fire alarm system designer. In many instances the owner has not considered any fire alarm system or protection goals beyond “just meet code.” “Just meeting code” has little significance unless the system designer is aware of all of the applicable state and local codes and standards that are in force in the jurisdiction where the fire alarm system is being installed. In addition, the owner should be advised that compliance with the applicable codes and standards may not meet his or her fire protection goals.

Another misconception that often arises during a fire alarm system installation is that if the system is “not required” by any specific code, then the designer and installer is not bound to follow the requirements of NFPA 72, the National Fire Alarm and Signaling Code®. Nothing could be further from the truth. The 2010 edition of NFPA 72 states that even non-required fire alarm system installations must follow the requirements of the Code. Logic would seem to require that in any case. Would you expect a doctor to not follow conventional and accepted operating procedures when the operation was elective?

Building and fire codes are designed to avoid conflagrations, not ensure the building will survive a fire. A “code minimum” often provides less protection than the owner expects. This fact

needs to be explained to the owner and then assistance should be provided to develop his or her fire protection goals for the specific building or application. Typically fire protection goals can be thought of as one or more of the following:

- Life Safety
- Property Protection
- Mission Protection
- Heritage Protection

## Life Safety Protection

Most residential (apartments, hotels, condominiums, etc.) applications of fire alarm systems are designed to enhance the life safety protection of the occupants. The phrase “life safety” is considered synonymous with “early warning.” The smoke detector is the automatic detection device of choice when an early warning fire alarm system is contemplated.

The Life Safety Code - 2009 edition, defines complete protection in paragraph 9.6.2.9 Where a total (complete) coverage smoke detection system is required by another section of this Code, automatic detection of smoke in accordance with NFPA 72, National Fire Alarm and Signaling Code, shall be provided in all occupiable areas in environments that are suitable for proper smoke detector operation.” It should be obvious that if the fire protection goal is life safety protection and therefore early warning of a fire is desired, smoke detectors must be installed as defined in the Life Safety Code – 2009 edition.

In reality, there are very few complete detection systems installed, as this would include detectors above the ceilings and similar spaces within the building. Even with detectors places throughout the premises below the ceilings, the system would be defined as be “partial” as defined by NFPA 72.

Striking the balance between effective protection and a stable fire alarm system can often be elusive. In order to accomplish our goal of life

safety protection, the installed system must be stable, as well as reliable, to ensure it will be credible in the eyes of the occupants. The environment is an especially important consideration when designing smoke detection systems.

Another important consideration of life safety fire alarm system applications is to ensure that notification appliances provide adequate warning. NFPA 72 – 2010, Chapter 18, paragraph 18.4.3.1 states that for “public mode notification,” that is, where all of the building occupants are notified of the fire, a sound pressure level of 15dBA above the ambient noise level or 5dBA above a maximum sound level lasting for at least 60 seconds, whichever is greater, is required. In addition the Life Safety Code - 2009 edition and the Americans with Disabilities Act (ADA) require that visible appliances be installed to assist in alarm notification of the hearing impaired.

NFPA 72 – 2010 Chapter 10 and 18 requires that a fire alarm evacuation signal shall be distinctive in sound from other signal, and shall comply with the requirements of 18.4.2.1. Their sound shall not be used for any other purpose. Paragraph 18.4.2.1 describes a temporal pattern. The temporal three pattern shall only be used if total evacuation of the building is required.

## Property Protection

The amount and type of detectors and the type of fire alarm system that one chooses for property protection will depend on the owner’s property protection goals, the value of the property and the requirements of the owner’s insurance company.

Generally, heat detection will be used in all areas that are not considered high value. Here again, one of the most common mistakes in fire alarm system application is to provide partial protection of a building and expect high performance from the installed system. Most insurance and fire service professionals would never consider a partial automatic sprinkler system consisting of sprinkler heads installed in selected rooms

or the hallways of a building to be effective in suppressing any size fire. But many individuals seem to think that a few heat or smoke detectors scattered about the building constitutes a “complete” fire alarm system.

Remember the goal for property protection is to reduce property losses due to fire. For any fire alarm system to be effective in accomplishing that goal, the building must have 100% coverage using automatic detection and be connected to a listed supervising station. The fire alarm system does not suppress the fire. To be of any use in property protection, the fire alarm system must be able to detect the fire and provide off-premises notification in enough time for the fire department to respond while the fire is still relatively small.

Typically but not always, heat detectors are used to provide property protection. The type of automatic heat detectors installed, fixed temperature, rate-of-rise, or rate compensated, will depend on the ambient temperature and environment in which detection is needed. Other forms of detection, spot type smoke detection, beam type smoke detection or flame detection, may also be used. Information regarding ceiling height, detector response time, fire department response time and availability of water should be considered to ensure the owner’s goals are met. Refer to Table on Page 18 for guidance.

## **Mission Protection**

“Mission protection” can be defined as the ability of a company or organization to stay in business after a major fire in their facility. Another way to look at the protection required in a facility is to determine whether or not each area of the building or an area which houses a certain business function (i.e., receivables computer, special finishing processes, etc.) will be able to withstand the impact of a fire. Then determine if the business function can maintain its operation after the fire. The results of this survey will of-

ten dictate which detection devices will meet the owner’s goals. If the area or business function is critical to the mission of the owner, faster forms of detection such as flame detectors or aspirating (active air sampling) types of smoke detection may need to be used.

If the loss of a particular area will have no appreciable impact on the ability of a company to conduct business in the future, the slower forms of detection (i.e., heat detection) can be used in that area or space.

## **Heritage Protection**

Protecting historical landmarks can be challenging. Many of these facilities are, or contain, treasures that cannot be replaced. Detection for this application normally must comply with two criteria: Early detection and preservation of the historic nature of the facility. The second item is often the most difficult to deal with. The directors of these facilities often agree that a fire alarm system is necessary but they do not want the system’s presence to detract from the presentation of the history of the facility.

In addition, many of these buildings are located in areas not easily accessible by the emergency responders and water availability is limited. The buildings are most often highly combustible structures and fire can spread very rapidly. These factors create a need for complete or total detection coverage throughout the building.

Because these buildings are irreplaceable, early detection is paramount. Generally spot-type or linear beam smoke detectors will provide the needed detection, however, air-sampling (aspirating-style) smoke detectors will provide the earliest protection. For more information regarding Heritage Protection, consult the National Fire Protection Association document, NFPA 909-2010, Code for the Protection of Cultural Resources Properties - Museums, Libraries, and Places of Worship.

<b>Detector Description</b>	<b>Application</b>
<b>HEAT DETECTORS</b>	
Fixed temperature, spot-type	Enclosed Areas (rooms, closets, etc.), primarily for property protection. Not considered an early warning device.
Rate of rise, spot-type	Enclosed areas (rooms, closets, etc.); primarily used for property protection where design goals require more sensitive heat detection and response to developing fires. Avoid use in areas of fluctuating ambient temperature. Not considered an early warning device.
Rate compensation	Same as for fixed temperature, spot-type heat detectors. Because of sealed design, may be used in dusty and moist areas. Spacing ratings are better due to reduced thermal lag.
Fixed temperature, line-type	Application is similar to spot-type. Used in severe environments, cable trays, wharf applications, and historic buildings.
<b>FLAME DETECTORS</b>	
Infrared/Ultraviolet	Special applications such as oil refineries, aircraft hangers, explosion or special hazard protection. Avoid use in areas where detectors are exposed to sunlight or welding unless the detector is listed for this environment. Must have an unobstructed view of the protected area.
<b>SMOKE DETECTORS</b>	
Ionization, spot-type	Early warning or life safety. This detector is most efficient when flaming fires are expected.
Photoelectric, spot-type	Most efficient when smoldering fires are expected or where the smoke has to travel a distance before reaching the detector ("aged" smoke).
Photoelectric, beam-type	Used in high ceiling environments such as churches, atriums and warehouses.
Photoelectric, air sampling-type	Used in high value applications, such as computer rooms; also used air sampling-type in high airflow areas and some rack storage application  Notification of occupants or others of potentially dangerous conditions, such as the presence of fuel gases or toxic gases such as carbon monoxide shall be permitted.
<b>CO, GAS AND OTHER FIRE DETECTORS</b>	
CO Detectors	Signals from carbon monoxide detectors and carbon monoxide detection systems transmitted to a fire alarm system shall be permitted to be supervisory signals.
Gas Detectors	Gas detection equipment shall be listed for detection of the specific gas or vapor to be encountered.
Other Fire Detectors	Detectors that operate on principles different from those covered by Sections 17.6 through 17.8 of NFPA 22-2010 shall classify as "other fire detectors. Such detectors shall be installed in all areas where they are required either by other NFPA codes and standards or by the authority having jurisdiction.

## Application Guidelines

### Time considerations

In addition to the type of fire and the rapidity with which it spreads, another important element to consider is the impact of time in the design of a fire alarm system. Heat detectors, sprinklers, and many other extinguishing devices or systems are rated in terms of response time. The fire resistance of building materials and assemblies are also rated in terms of time. The evacuation needs of the occupants are also measured in terms of time.

Time considerations are of paramount importance in the detection of a fire and in safe evacuation of occupants from the protected premises.

For life safety applications, the main objective of the design is to ensure that the occupants have time to escape safely before the conditions in the protected premises reach intolerable levels of smoke, heat and gas.

For property protection, the design should take into consideration the response time of the fire department as well as their capabilities. An extended response time allows the fire to grow to a size beyond the capabilities of the fire department to control and extinguish the fire before a major loss occurs. Similar consideration should be given to the availability and condition of the water supply. If the water supply is questionable or inadequate, the fire department will likely have to “bring the water with them” in order to suppress the fire. If this is the case, the fire alarm system will need to detect the fire while it is small enough to allow the fire department to respond and still be able to control and suppress the fire with the available water supply.

### Detector Selection

In the design of a fire alarm system, consideration must be given to the types of detection that will meet both the owner’s fire protection goals and the system design goals. The detector’s operating characteristics, environmental conditions where the detector will be placed; the type of combustible material and ceiling height all affect the ability of the detector to provide the expected protection.

The concept of “levels of coverage” has been used in generally three ways in NFPA 72-2010, paragraph 17.5.3:

#### 1. Total (Complete) Coverage

Where required by laws, codes, or standards, and unless otherwise modified by 17.5.3.1.1 through 17.5.3.1.5, total coverage shall include all rooms, halls, storage areas, basements, attics, lofts, spaces above suspended ceilings, and other subdivisions and accessible spaces, as well as the inside of all closets, elevator shafts, enclosed stairways, dumb-waiter shafts, and chutes.

#### 2. Partial Coverage or Selective Area Coverage

Where codes, standards, or laws require the protection of selected areas only, the specified areas shall be protected in accordance with this Code. As stated above, the majority of fire detection systems that are installed are partial. The coverage of the detectors still may cover most areas below the ceilings, but may not be in spaces such as closets, underneath stairs and similar locations.

Selective coverage is where a specific hazard within a room or space is being covered, but other spaces are not. With partial and selective coverage, the prescriptive coverage requirements of the Code still must be followed for the spaces or areas that are to have detection.

### 3. Nonrequired Coverage

Detection installed for reasons of achieving specific fire safety objectives, but not required by any laws, codes, or standards, shall meet all of the requirements of this Code, with the exception of the prescriptive spacing criteria of Chapter 17.

A detector application guide is given in Table 2.1. This guide should be used in conjunction with Chapter 17 of the National Fire Alarm and Signaling Code - 2010 edition and with the guidance of a qualified fire alarm system designer such as a licensed fire protection engineer.

Two major factors that impact the effectiveness and reliability of automatic fire detector operation are ceiling height and detector spacing.

#### Ceiling Height

When ceiling height exceeds 10 ft., heat detector spacing must be reduced. The reduction required is given in NFPA 72 -2010, paragraph 17.6.3.5 High Ceilings. Early detection of smoldering fires with spot-type smoke detectors installed on high ceilings (greater than fifteen feet, for instance) is nearly impossible. A fire plume has an inverted cone shape; as the fire intensifies, smoke and heat rises and the cone angle narrows. The fire plume becomes almost non-existent where there is a smoldering fire. The smoldering fire is difficult to detect because there is no flame or heat to drive the combustion products to the ceiling. Once the fire intensifies, the combustion products will be driven to the detector, however, detection at this time could hardly be called early warning.

#### Detector Spacing

The National Fire Alarm and Signaling Code - 2010 edition, Chapter 17 provides guidance for spacing and placement of smoke detectors. Early installation, that is installing smoke detectors prior to the final cleanup by all construction trades, is not allowed by the Code.

Guidance for the spacing for all detectors is outlined in Chapter 17 of the National Fire Alarm and Signaling Code - 2010 edition and for some detectors (heat detectors, for example) spacing is dictated by the results of test conducted by Underwriters Laboratories or Factory Mutual Research Corporation. In most cases, building codes and fire authorities will refer all spacing considerations to the requirements of NFPA 72, Chapter 17 and to engineering judgment. If faster response by a detector to a fire is desired, spacing should be reduced. Detector spacing is also reduced if there are ceiling obstructions or high velocity air movement. High airflow affects smoke detection and must always be considered. Smoke detectors should not be located in the direct airflow path, or within three feet, of an air-supply diffuser.

## Basic Fire Alarm Systems

Fire Alarm systems perform several functions vital to limiting life and property losses during fires. They can provide fire detection, early warning for evacuation, and local fire brigade (Emergency Response Team) or public fire department notification.

As stated previously, the importance of having a basic understanding of what makes up a typical fire alarm system cannot be overemphasized. It is equally important to be familiar with the National Fire Alarm and Signaling Code, as it is to understand how the fire alarm system functions.

### Fire Alarm System Components

A designer can create a complex fire alarm system that serves the purpose but is difficult to maintain. Or that same designer can create a fire alarm system that bristles with simplicity. The primary goal of any fire alarm system should be to operate reliably over the life of the installation. To accomplish that goal, one must understand the operation of the fire alarm system components and the basic requirements for the installation of fire alarm system.

Equipment constructed and installed in conformity with the National Fire Alarm and Signaling Code, shall be listed for the purpose for which it is used. System components shall be installed, tested, and maintained in accordance with the manufacturer's published instructions and this Code. All devices that receive their power from the initiating device circuit or signaling line circuit of a control unit shall be listed for use with the control unit.

### Basic components of a fire alarm system

The following is a list of the basic components that can be installed together to make up a typical fire alarm system:

#### Alarm Initiation Devices

- Manual Fire Alarm Boxes
- Waterflow Initiating Devices
- Heat Detectors
- Smoke Detectors
- Radiant Energy Sensing Fire Detectors
- Other Fire Detectors

#### Notification Appliances

- Bells
- Horns
- Speakers
- Sirens
- Strobes
- Combination units

#### Fire Alarm Control Units

- System Operating Configuration
- Conventional fire alarm systems
- Addressable fire alarm systems
- Analog-addressable fire alarm systems

#### Remote On-Site Annunciation

- Point Lighted
- Alphanumeric
- Liquid Crystal Displays (LCD's)
- Graphic

#### Batteries

- Standby Power

## Alarm Initiating Devices

### Manual Fire Alarm Boxes

Manual fire alarm boxes should be installed at unobstructed, readily accessible locations throughout the protected area with at least one box on each floor. Travel distance to a box should not exceed 200 ft. from any point in the area. The operable part of each manual fire alarm box shall be not less than 42 in. (1.07 m) and not more than 48 in. (1.22 m) above floor level and, the box location should be positioned in the normal path of exit from the area. The mounting surface shall be of a contrasting color.

### Types of Manual Fire Alarm Boxes (Stations)

#### 1. Non-coded

(a) Contains a normally open or closed switch that is housed within a distinctive enclosure. Once actuated, the box must be reset to restore the unit to normal.

(b) Contact and circuit arrangements may vary to provide a number of functions simultaneously.

#### 2. Coded

(a) Contains a mechanically or electrically driven motor, or an electronic pulse generator. When activated, the motor turns a code wheel causing contacts to momentarily open or close or the pulse generator operates to reproduce the code of the box. The box is required to repeat its code a minimum of three times.

(b) Contact and circuit arrangements may vary to provide a number of functions simultaneously.

#### 3. Breakglass

To initiate an alarm, one must first break glass or some other element. The purpose is to identify which box was operated and to discourage tampering with the box when there is no fire to report.



Breakglass Fire Alarm Box

#### 4. Non-Breakglass

A manual fire alarm box that does not have a breakglass feature.

#### 5. Single Action

A single action of breaking a glass or other frangible element or pulling a lever or other movable part initiates an alarm.

#### 6. Double Action

Two actions are necessary to initiate an alarm. Either break a glass to open a door or lift a cover to gain access to a switch or lever to initiate an alarm.

NFPA 72 -2010, National Fire Alarm and Signaling Code further specifies in Chapter 17 how manual fire alarm boxes are to be installed and distributed.

Depending on the type of manual fire alarm box that has been selected, it will have several of the features that have been described above.

Manual fire alarm boxes may be used for the following types of systems:

#### General Alarm

When activated, the fire alarm evacuation signals sound immediately throughout the premises.

### **Pre-signal**

Initial fire alarm signals only sound at designated areas. The subsequent actuation of a key switch on the box (or control panel) causes an evacuation signal to sound throughout the premises.

### **Waterflow-Actuated Fire Alarm Initiating Devices**

The fire alarm system should monitor the operation of the automatic sprinkler system and other fire extinguishing and suppression systems by means of listed fire alarm initiating devices. When the automatic sprinkler system operates, the waterflow-actuated fire alarm initiating device will initiate a fire alarm signal.

The fire alarm system should also monitor the normal standby condition of these extinguishing or suppression systems by means of listed supervisory initiating devices. If someone closes a sprinkler system control valve or otherwise impairs the protective system, the supervisory initiating device will cause the fire alarm system control unit to indicate a “supervisory off-normal condition.” When the valve is reopened or the other impairment is cleared, the supervisory initiating device will cause the fire alarm system control unit to indicate a “supervisory restoration to normal signal.”

The waterflow alarm and the supervisory initiating devices must be monitored separately to enable the differentiation between waterflow, trouble and supervisory conditions. Generally with conventional hard-wiring systems this requires a separate zone for waterflow alarm and one for supervisory initiating devices with the supervisory device being a “normally-open” device.

There are four basic types of automatic sprinkler systems that an alarm system may be connected to:

- Wet Pipe
- Dry Pipe
- Pre-Action
- Deluge

While a vane flow switch may be used on a wet pipe system, a pressure flow switch is required for the supervision of dry pipe, pre-action and deluge systems.

### **Automatic Fire Detectors**

Fire produces well-defined signatures, most commonly: heat, smoke, and radiant energy. Fire alarm system designers normally select automatic fire detectors to detect these signatures in accordance with the requirements of Chapter 17 of the National Fire Alarm and Signaling Code. This Chapter not only details the selection of detectors, it also sets forth the rules for the spacing and installation of these devices.

Automatic fire detectors may have a defined linear spacing that is assigned through testing by a nationally recognized testing laboratory (spot-type detector), or protect an area along the entire length of a detector (line-type detector).

### **Heat Detectors**

Heat detectors respond to the thermal energy signature from a fire and are generally located on or near the ceiling. They respond when the detecting element reaches either a predetermined fixed temperature or a specified rate of temperature rise occurs. Knowing the difference between types of detectors is very important. Periodic tests must be made of all detectors. Applying a safe source of heat can test restorable detectors, while non-restorable detectors must be tested mechanically or electrically. It is

important to know which types of heat detectors are installed so that tests can be made on all restorable heat detectors, but not on the fusible elements of non-restorable detectors.

**Fixed-Temperature Heat Detectors:**

These detectors initiate an alarm when the detecting element reaches a predetermined fixed temperature. Because of inherent thermal lag, when the detector actually operates, the temperature of the air surrounding the detector has always extended considerably higher than the set point of the detector.

One form of a spot-type fixed temperature detector uses a fusible element made from a eutectic metal alloy that melts rapidly at a predetermined temperature (commonly 135°F). Automatic sprinklers, fire dampers

and door fusible links commonly use a similar material. The operation of the detector destroys either the entire unit (or at least the operating element) which the person who maintains the system must replace. Another form of spot-type fixed-temperature heat detector uses a bimetallic element. After operating, the bimetallic type automatically restores when the temperature falls to a point below the set point of the detector.

**Rate-of-Rise-Compensated Fixed Temperature Detector:**

In a slowly developing fire, this form of detector responds when the temperature of the air surrounding the detector reaches a predetermined level. In a rapidly developing fire, the detector anticipates the air temperature reaching the operating point, and accelerates the operation of the detector. This produces a fixed temperature detector with virtually no thermal lag.

**Rate-of-Rise Detector:**

A rate-of-rise detector will operate when the rate of temperature increases from a fire exceeds a predetermined level, typically around 5°F in twenty seconds or 15°F per minute. Small, normal changes in ambient

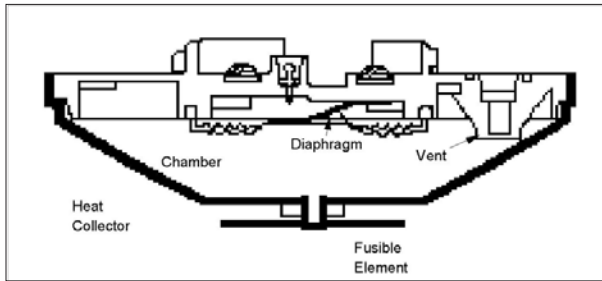

Combination Rate-of-Rise/Fixed-Temperature Heat Detector

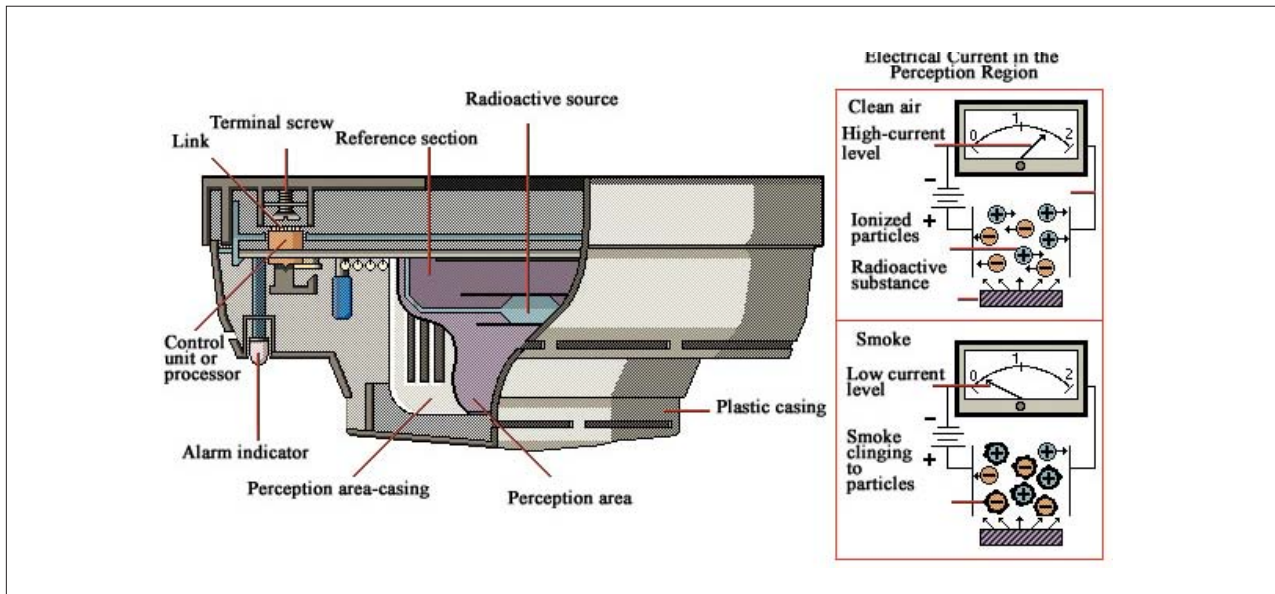

Ionization Smoke Detector

temperature that can be expected under non-fire conditions will not operate the detector. These detectors are available as both line-type or spot-type detectors, and are restorable.

**Linear Heat Detector:**

For some applications, the use of a linear heat detector is an option to consider. These may be installed in head to reach areas, or areas that are subject to high heat. The detector is contained within a cable which when exposed to heat that is greater than its rating, will short circuit, causing an alarm.

**Combination Detector:**

Detectors can contain more than one element to respond to a fire. Examples include a combination rate-of-rise and fixed-temperature heat detector, or a combination of a smoke detector and a heat detector.

**Smoke Detectors**

The result of full-scale fire tests, using typical fires in family living units, have shown that

detectable quantities of smoke precede detectable levels of heat in nearly all cases. Thus fire alarm system designers use smoke detectors more extensively today. The common operating characteristics of smoke detectors include the ionization spot-type smoke detector, the photoelectric spot-type smoke detector, liner beam-type smoke detector, the air-sampling smoke detector and the duct-type smoke detector.

**Ionization Smoke Detector:**

An ionization smoke detector has a small amount of radioactive material that ionizes the air in the sensing chamber, thus rendering it conductive and permitting a current flow through the air between two charged electrodes. When smoke particles enter the chamber, they attach themselves to the ionized air molecules and decrease the conductivity between the electrodes. This decrease in conductivity can be measured by an electronic circuit that initiates a fire alarm signal when the reduction in conductivity reaches a pre-set threshold.

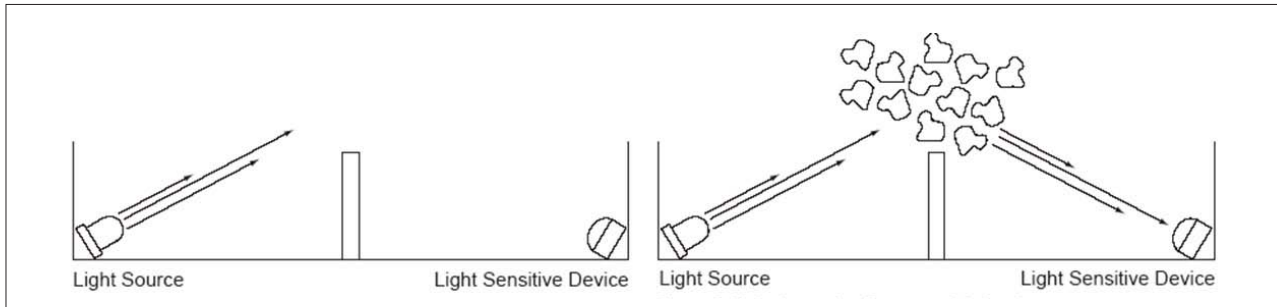

Photoelectric Light-Scattering Smoke Detector

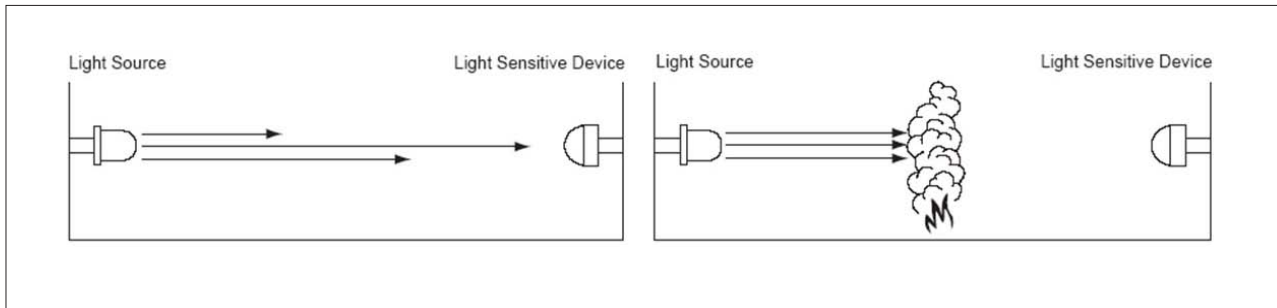

Photoelectric Linear Projected Beam Smoke Detector

### Photoelectric Light-Scattering Smoke Detector:

In a photoelectric light-scattering smoke detector, a light source and a photosensitive sensor are arranged so that the rays from the light source do not normally fall on the photosensitive sensor. When smoke particles enter the light path, some of the light is scattered by reflection and refraction onto the sensor, causing the detector to initiate a fire alarm signal.

### Photoelectric Linear Projected Beam Smoke Detector:

In a photoelectric linear projected beam smoke detector, a light source and a photosensitive sensor are arranged across a protected space so that the rays from the light source normally fall on the photosensitive sensor. When the smoke particles enter the light path, the intensity of the light is reduced, causing the detector to initiate a fire alarm.

There have been recent discussions on when to use an ion or a photoelectric detector. The system designer and user should be aware of the type of fire that may have a higher probability of starting in a space where detection is to be installed. Ion detectors are better at the detection of fast, flaming fires while photoelectric detectors have demonstrated a higher response to smoldering fires. There

has been a move by some jurisdictions to either not allow the use of ion detectors or require the use of a combination.

### Air-sampling Smoke Detector:

In an air-sampling smoke detector, a system of tubing and sampling ports draws a sample of air from a protected space into a detection unit. When smoke particles in the air sample enter a detection chamber, the presence of the particles causes the detector to initiate a fire alarm signal.

### Air Duct-type Smoke Detector:

Detects smoke for the primary purpose of controlling the propagation of smoke through the heating, ventilation and air conditioning system (HVAC). This helps prevent possible panic and damage from distribution of smoke and gaseous products. These detectors only detect smoke when smoke is circulation in the duct. They sample a small amount of great volumes of air from large areas of coverage. Air duct smoke detectors are not a substitute for:

- Area smoke detection
- Early warning
- A building's regular fire detection system

Heat detectors have a listed spacing, smoke detectors do not. The manufacturer of the smoke detector determines the recommended spacing. If the manufacturer does not recommend a specific spacing, then the National Fire Alarm and Signaling Code Chapter 17 recommends a spacing of 30 ft. on center.

When spot type heat detectors are to be installed, Table 17.6.3.5.1 from NFPA 72 needs to be consulted. This table specifies the spacing reduction for spot type heat detectors as the ceiling height is increased. There are required reductions for any ceiling that is above ten feet.

While there is not height reduction for smoke detector, the stratification of smoke does need to be taken into consideration.

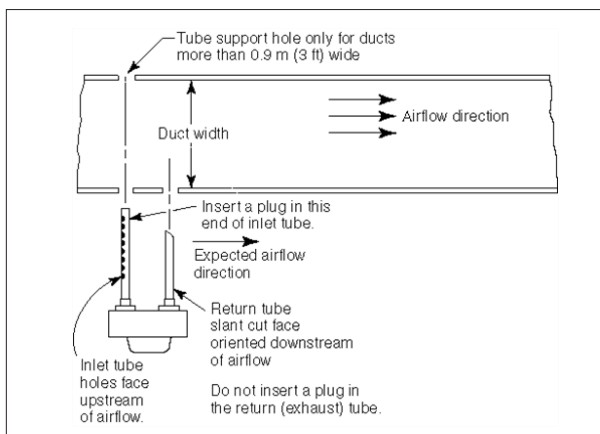

Air Duct-type Smoke Detector



Typical Notification Appliances

### Radiant Energy Detectors

#### **Radiant Energy Sensing Fire Detectors:**

Designers specify flame and spark/ember detectors for sophisticated detection applications. Custom-engineered for each particular protected space, these detectors often actuate special hazard fire extinguishing or suppression systems.

### Notification Appliances

NFPA 72-2010, Chapter 18 requires that audible appliances provide a minimum sound pressure level of 15dBA above the ambient noise level or 5dBA above a maximum sound level lasting for at least 60 seconds, whichever is greater. In addition the Life Safety Code – 2010 edition and the Americans with Disabilities Act (ADA) requires that visible appliances be installed to assist in the alarm notification of the hearing impaired. Strobes must be placed in accordance with NFPA 72-2010, Chapter 4 requirements to ensure proper coverage while avoiding excessive flash rates that may trigger a seizure with photosensitive epileptic prone individuals.

NFPA 72 also requires that all audible evacuation signals conform to the American National Standard Evacuation Signal, ANSI S3.41. This temporal code 3 signal must be synchronized within a notification zone. The temporal three code is only to be used when total evacuation of a building is to occur.

### Bells

Bells may be used for fire alarm signals where their sound is distinctive and will not be confused with similar audible signals used for other purposes. Bells are normally operated by 12 or 24 volts DC (direct current) and may be of the single-stroke or vibration type connected in parallel.

Bells may be provided with 4-inch through 12-inch gongs (in 2-inch increments). The 6- and 10-inch sizes are the most commonly used. Usually, bells with 4-inch gongs are reserved for use as trouble signals. Generally, the larger the diameter of the gongs the lower the frequency and the louder the audible signal (expressed in terms of decibels [dB]).

### Horns

Horns are provided for applications that require louder or more distinctive signals, or both. Horns may be operated by either alternate or direct current and may be connected in series or parallel. Care should be exercised to see that circuits are electrically compatible when powering both types of appliances. Horns that are manufactured today are generally 12 or 24 VDC.

Horns are usually of the continuous vibrating or electronic type and may be used to provide either coded or non-coded audible alarm signals.

They may be of the surface, flush, semi-flush, single projector, double projector, or trumpet type.

In very noisy areas, resonating, air-powered or motor-driven horns are sometimes used because of their inherently higher decibel output. NFPA 72 stipulates that the sound pressure from a notification appliance may not exceed 110 dBA.

### Speakers

Speakers are frequently used as fire alarm signaling appliances. Since they reproduce electronic signals, they can be made to sound like any mechanical signaling device and have the capability of reproducing unique sounds that are not practical on mechanical appliances. In addition, they may be used to give live or recorded voice instructions. Speakers are either direct radiating cone type, or of the compression driver and horn type.

Speakers are generally operated from audio amplifiers delivering standard output line levels of 70.7 or 25 volt AC rms. The speakers are driven by an electronic tone generator, microphone, or voice synthesizer and an electronic amplifier. Two types are in wide use:

**Integral** – that type in which the tone generator amplifier, and speaker are enclosed in a common housing.

**Remote** – that type in which the speaker is energized from a remotely located tone generator, microphone and/or voice synthesizer and amplifier.

### Sirens

Sirens usually are limited to outdoor applications but are sometimes used in extremely noisy indoor areas. Sirens are motor-driven or electronic appliances and may be either alternating or direct current operated. They are not very practical for use as coded audible signals.

### Strobes

Strobe lights operate on the energy discharge principle to produce a high intensity flash of short duration. These lights are very efficient. The short bright flash is not only attention getting but is effective when general visibility is low. Strobe appliances come in a wide range of light intensities and operating voltages. Repetition rates are not allowed to exceed two flashes per second nor less than one flash every second throughout the listed voltage range of the appliance.

### Combination units

The audible and visible functions can be combined in one unit to produce both sound and light from a single appliance. For example, the sounder can be a horn, bell, or speaker. The light is required to be a strobe with specific characteristics as described in Chapter 18 of the 2010 National Fire Alarm and Signaling Code. Advantages of the combined signals are:

- The visible signal localizes the particular audible alarm appliance that is operating.
- The visible signal produces a recognizable alarm when an ambient noise level may affect the audible signal.
- Persons having impaired hearing can see the visible portion of the alarm signals.

The combined signals are available in all voltages up to line voltage. Twenty-four volt dc units are the most prevalent. Polarized versions facilitate line monitoring. Two or four-wire connected types permit application of either a common or separate power supply.

Combination appliances are not required at every location throughout a building. Fire alarm system designers normally (following the requirements in Chapter 18 of NFPA 72-2010) will design the visible appliance layout first and then design the audible appliance layout. Then wherever both audible and visible appliances are in the same general location, those units would be specified as combination units.

## Fire Alarm Control Units (Panels)

The primary purpose of the fire alarm control unit is to process signal received from initiating devices and to output appropriate signals to notification appliances and the off-premises supervising station. Typically the control unit is a microprocessor (similar to a computer) and can be programmed for many additional functions. The 2010 edition of the National Fire Alarm and Signaling Code requires that a detector be installed to provide protection of the fire alarm control unit in accordance with Chapter 10. This requirement for smoke detection applies to any remote power supplies or NAC extenders as well. Where ambient conditions prohibit installation of automatic smoke detection, automatic heat detection shall be permitted.

In addition, where connected to a supervising station, fire alarm systems employing automatic fire detectors or waterflow detection devices shall include a manual fire alarm box to initiate a signal to the supervising station. This is intended to provide a backup means to manually activate the fire alarm system when the automatic fire detection system or waterflow devices are out of service due to maintenance or testing, or where human discovery of the fire precedes automatic sprinkler system or automatic detection system activation.

Fire alarm system can have multiple operating configurations:

- Conventional
- Addressable
- Analog/Addressable (sometimes called “intelligent” system)

Conventional systems are normally used in small buildings applications where point identification of the device in alarm is not considered necessary. Addressable fire alarm systems provide detail as to the device in alarm or trouble.

Addressable and Analog/Addressable fire alarm systems are designed to identify the device that has been actuated. Analog/Addressable detectors may be adjusted for different sensitivity levels, depending on the environment that the detector is to be installed within.

These systems will also indicate when a device is approaching an alarm state due to contamination and will allow the sensitivity of analog smoke detectors to be individually set at the fire alarm control unit. The more complex systems require programming and specialized maintenance but once properly installed have proven to be more stable.

## Remote Annunciation

Annunciation is designed to direct the responding fire department to the fire location. Because of this important function, the fire department should always be consulted as to the acceptable labeling of the zones or point identification supplied by the fire alarm control unit. There are many types of annunciators that can be used depending on the complexity of the building or area to be described. The most common are:

- Point lighted
- Alpha-numeric
- Liquid Crystal Display (LCD)
- Point-lit graphic
- Back-lit graphic

## Battery Standby Power

Batteries are used to supply the fire alarm system with the required amount of secondary (standby) power. Most fire alarm systems that are connected to a central station must have 24 hours of battery standby power with an additional amount of power to operate the notification appliances for 5 minutes. If a voice evacuation system is installed, then 15 minutes of alarm power is required.

There are various types of batteries, the most commonly found in fire alarm systems are:

- Sealed gelled electrolyte
- Sealed lead acid
- Sealed lead calcium
- Sealed nickel cadmium

On some occasions, the standby power is supplied by a generator. When this is the case, four hours of standby battery power is required.

### Battery Calculations

How do you ensure the battery that is to be used with the fire alarm system under evaluation will provide the standby power required by the National Fire Alarm and Signaling Code? After everything that will be connected to fire alarm control panel and the size of the control panel is known, the amount of standby power required can be calculated.

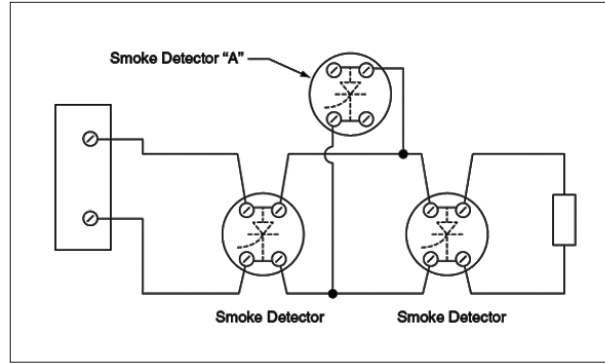

“T” Tap Diagram

It is not expected that the system reviewer will actually calculate the amount of battery standby. It is enough for you to know that it can be done. Your responsibility is to ask for these calculations and be able to review them for completeness.

A typical battery calculation could look like the following:

Fire Alarm System Secondary Battery-set Calculation Worksheet									
ITEM	DESCRIPTION	STANDBY CURRENT PER UNIT (AMPS)		QTY		TOTAL STANDBY CURRENT PER ITEM	ALARM CURRENT PER UNIT (AMPS)		TOTAL ALARM CURRENT PER ITEM
FACP	Fire Alarm Control Panel	0.2500	X	1	=	0.2500	0.5000	X	0.5000
ANN	Annunciator	0.1250	X	1	=	0.1250	0.2500	X	0.2500
SMOKE	Smoke Detector	0.0001	X	24	=	0.0024	0.0010	X	0.1000
HEAT	Heat Detector	0.0000	X	10	=	0.0000	0.0000	X	0.0000
PULL	Pull Station	0.0000	X	14	=	0.0000	0.0000	X	0.0000
BELL	FDC Bell	0.0000	X	3	=	0.0000	0.0500	X	0.0500
HORN	Horn	0.0000	X	0	=	0.0000	0.0500	X	1.0000
STROBE	Strobe	0.0000	X	14	=	0.0000	0.1000	X	4.0000
H/S	Horn/Strobe	0.0000	X	26	=	0.0000	0.1500	X	3.0000
0	0	0.0000	X	0	=	0.0000	0.0000	X	0.0000
0	0	0.0000	X	0	=	0.0000	0.0000	X	0.0000
0	0	0.0000	X	0	=	0.0000	0.0000	X	0.0000
0	0	0.0000	X	0	=	0.0000	0.0000	X	0.0000
<b>TOTAL SYSTEM STANDBY CURRENT (AMPS)</b>						<b>0.3774</b>	<b>TOTAL SYSTEM ALARM CURRENT (AMPS)</b>		<b>8.9000</b>
<b>Prepared for:</b>		<b>REQUIRED STANDBY TIME (HRS) NFPA 72-2010 10.5.6.3.1</b>		<b>TOTAL SYSTEM STANDBY CURRENT (AMPS)</b>		<b>REQUIRED STANDBY CAPACITY (AMP-HOURS)</b>	<b>REQUIRED ALARM TIME (HOURS) NFPA 72-2010 10.5.6.3.1</b>		<b>REQUIRED ALARM CAPACITY (AMP-HOURS)</b>
		24	X	0.3774	=	9.0576	0.083	X	0.7387
<b>Prepared by:</b>		<b>REQUIRED STANDBY CAPACITY (AMP-HOURS)</b>		<b>REQUIRED ALARM CAPACITY (AMP-HOURS)</b>		<b>TOTAL CAPACITY (AMP-HOURS)</b>	<b>TOTAL CAPACITY (AMP-HOURS)</b>		<b>ADJUSTED BATTERY CAPACITY (AMP-HOURS)</b>
		9.06	+	0.7387	=	9.7963	9.7963	+	12

Typical battery calculation

## Fire Safety Control Functions

Elevator recall, automatic door unlocking, door hold-open, and smoke damper release are all examples of fire safety control functions. In fact, any function that is designed to make the building or occupants safer from the impact of fire can be called a fire safety control function. These functions are always interconnected to the fire alarm control unit. The interconnections between the fire safety control function and the fire alarm control unit are monitored for integrity unless the operation of the fire safety control function is connected in a fail-safe fashion. The detailed requirements for these fire safety functions can be found in Chapter 23 of the National Fire Alarm and Signaling Code. NFPA 2010

## Fire Alarm System Wiring

The National Fire Alarm and Signaling Code requires that all fire alarm system wiring be monitored for integrity. This function may be accomplished in one of two ways. In conventional system, a small amount of current is passed through the wire, through the end of the line resistor, and back through the wire to the fire alarm control unit. To achieve continuity of the monitoring, no branch circuits (called “T-tapping” – see figure below) are permitted in conventional systems. In addressable and analog addressable systems, the connection devices are interrogated and if they answer the fire alarm control unit, then they are connected and the wiring is obviously intact.

Several classes of wiring configurations or pathways are described in Chapter 12 Circuits and Pathway. Pathways shall be designated as Class A, Class B, Class C, Class D, Class E, or Class X, depending on their performance. This chapter also deals with Pathway Survivability.

A cable that was permitted to be used by NFPA 72 several cycles ago called Circuit Integrity (CI) Cable, has been recognized in the 2010 National Electrical and Signaling Code. This

cable had been designed to continue functioning during a fire up to the melting point of copper. Its use will cause the fire alarm circuits to meet the survivability requirements of the National Fire Alarm and Signaling Code. If the system is critical to the fire protection goals of the owner, a designer will want to include the requirement of Circuit Integrity Cable in his or her specifications.

## NFPA 70-2009, National Electrical Code® (NEC)

In addition to compliance with the National Fire Alarm and Signaling Code the installation wiring must comply with the requirements of NFPA 70-2009, the National Electrical Code. Article 760-8 of NFPA 70-2009 requires that “fire alarm circuits shall be stalled in a neat and workmanlike manner. Cables shall be supported by the building structure in such a manner that the cable will not be damaged by normal building use.” In addition, Article 760-10 states “Fire alarm circuits shall be identified at terminal and junction locations, in a manner that will prevent unintentional interference with the signaling circuit during testing and servicing.”

The following additional requirements are based on the National Electrical Code (NEC):

- All cable must be Listed for the purpose
- All wire used in a fire alarm system must be copper
- Where system wires pass through floors of fire rated walls, the installation shall be made to prevent the spread of fire from floor to floor.
- A minimum of 6 inches of free conductor is required in each electrical box to facilitate terminations.
- All wiring shall be terminated with Listed devices such as wire nuts, pressure connectors or terminals. Electrical tape covering connections is not acceptable.

In addition, the following are recommended:

- The fire alarm system should comply with local wiring requirements
- All initiating device, notification appliance and signaling line circuits must be free from grounds and short circuits.
- The manufacturer will specify the maximum allowable loop resistance allowed on each circuit to be connected to the control unit. This loop resistance must not be exceeded.

Annex G within NFPA 72 contains the outline of each section of Article 760 of the National Electrical Code that states the requirements for the installation of fire alarm systems. The installation wiring must comply with Article 760 as well as the referenced sections of Chapter 3 of NEC.

There are two types of installation wiring allowed for fire alarm systems:

- Power Limited
- Non-Power Limited

The advantage of using power limited fire alarm systems is that the wiring may run exposed where it is not subject to physical damage. The requirements for both power limited and non-power limited wiring configurations are contained in Article 760 of the NEC. One must keep in mind that a low voltage (12VDC or 24VDC) fire alarm system may not be power limited. The manufacturer and the listing process determine whether or not a fire alarm system circuit is power limited. If the circuit is non-power limited then the wiring must conform to non-power limited wiring configurations or the wiring methods described in Chapter 3 of the NEC.

## Types of Fire Alarm Systems

Although there are six general types of commercial and industrial fire alarm systems: central station, protected premises (local), auxiliary, Remote Supervising Station, Proprietary Supervising Station, and emergency voice/alarm communication, there are some basic features to all systems. Each has alarm initiating device circuits that provide a means of interconnecting the fire alarm control unit with manual fire alarm boxes, waterflow – actuated alarm initiating devices, automatic fire detectors, or other fire alarm initiating devices. The control unit has both a primary (main) power supply and a secondary (standby) power supply.

Protected premises (local) fire alarm systems and emergency voice/alarm communication systems have one or more notification appliance circuits that connect audible and visible alarm notification appliances to the fire alarm control unit. These alarm notification appliances notify people at the protected property of the fire condition. Depending on the needs of the property protected, the audible or visible alarm notification appliances may consist of bells, horns, sirens, chimes, loudspeakers, strobe lights, annunciators, punch tape registers, alpha – numeric printers or digital displays on a visual display unit.

The four types of systems which have signaling line circuits that interconnect the fire alarm control unit with a supervising station that in turn monitors the signals from the fire alarm system include:

- Central Station
- Proprietary Supervising Station
- Remote Supervising Station
- Auxiliary

Generally, protected premises fire alarm systems and emergency voice/alarm communication systems provide life safety protection by notifying occupants to evacuate or relocate during a fire

emergency. Such systems may provide property protection by notifying members of the guard force of a local fire brigade of the need to respond to the location of a fire.

In contrast, central station, auxiliary, Remote Supervising Station and Proprietary Supervising Station system provide property protection by summoning the public fire department. Proprietary Supervising Station systems may also summon the local private fire brigade or emergency response team. These systems may provide life safety protection if they have an interface to a protected premises fire alarm system or emergency voice/alarm communication system.

#### Protected Premises Fire Alarm System

The main purpose of a protected premises fire alarm system is to sound local alarm signals for evacuation of the protected building.

A system could be limited to the basic features indicated earlier. A protected premises system stand by power supply must operate the system for a minimum 24 hrs under normal load and then be able to operate the alarm system for 5 min in an alarm condition.

In a protected premises fire alarm system, the alarm is not relayed automatically to the fire department. Instead, when the alarm sounds, someone must use some other means to notify the fire department. If the building were unoccupied at the time of the alarm, fire department response would depend upon a neighbor or passerby hearing the audible fire alarm signaling appliance and notifying the department.

#### Emergency Voice/Alarm Communication System

This system is used to supplement a protected premises where it is necessary to select evacuate or relocate occupants to areas of refuge, rather than evacuate them. Its standby power supply must operate the system for 24 hrs, followed by 15 minutes of operation during an alarm. Because of the emergency nature of a voice

communication system, special requirements in NFPA 72, the National Fire Alarm and Signaling Code, also cover the survivability of the system, so that fire damage to one paging zone will not result in loss of communication to another if there is to be partial evacuation.

The voice/alarm system consists of a series of high reliability speakers located throughout the building. They are connected to, and controlled from, the fire alarm communication console located in an area designated as the building fire command station. From the building fire command station, individual speaker zones or the entire building can be selected to receive voice messages that give specific instructions to the occupants. Some systems have fire warden stations on each floor, or fire zones, to which a fire warden would go to assume local command and pass on specific evacuation instructions. The fire command station is usually operated by a trained building employee until the fire department arrives, at which time the officer in charge takes over. The system may also be used during fire fighting operations for communication with the fire fighters.

One important aspect of a voice communication system is that since complete building evacuation is not always feasible, it can instruct occupants to relocate to "Safe" areas where they can wait out the fire. In such cases, communication with these people must be maintained to prevent panic and to facilitate further relocation of necessary. NFPA 72-2010 requires that the notification appliances circuits meet certain survivability characteristics and continue to operate during a fire. The Code offers various alternatives to meet these requirements including installing the cable serving the notification circuits in a 2-hour shaft or in a stairwell in a completely sprinklered building or through the use of Circuit Integrity (CI) cable or other 2-hour rated cable installed in a raceway. The goal of course is allow the voice communication system to be used continuously throughout the fire incident.

A relative new requirement within NFPA 72

is voice intelligibility. This is the ability of a person that is within a space to be able to understand the message. NFPA 72 recommends that a Speech Transmission Index (STI) of 0.7 be achieved within a space. When laying out a voice evacuation system, the designer shall specify Acoustically Distinguishable Spaces (ADS). Each ADS shall then be identified as requiring or not requiring voice intelligibility. A new Annex D in NFPA 72 provides useful information on this subject.

### Central Station Service

The most effective means of transmitting alarms off-premises is through the use of Central Station Service. A fire alarm system for central station service is designed to receive signals from a protected premise at a constantly attended location operated in accordance with UL (Underwriters Laboratories Inc) or FMRC (Factory Mutual Research Corporation) standards; by a company whose purpose is providing central station service.

In the past, signals may have been transmitted from a protected premises using either traditional direct-current-coded circuits, often referred to as McCulloh circuits or by means of three types of multiplex signaling systems, including telephone-company-provided derived local channel systems.

The most common way today is by means of digital alarm communicator systems. Other methods are by means of two-way radio frequency (RF) multiplex communications systems; by means of a combination of single-line digital alarm communicator transmitter and a one-way RF transmitter system; or by means of a one-way RF communications system. A more detailed list of fire alarm transmission methods is provided below.

When they receive fire alarm signals, operators at the central station retransmit those signals to the public fire service communications center.\*  
(NOTE: In some cities the public fire service

*communications center is a part of a listed central station. This allows the central station to dispatch fire fighting equipment directly.*) In addition, the central station either directly or through a subcontractor provides emergency runner response to the various signals received. The central station also must supply repair service in case of a trouble signal, with the repair person reaching the protected premises within 4 hours.

The power supply at the protected premises must provide a minimum of 24-hour standby operation from rechargeable batteries. The standby power supply at the central station must supply energy to operate the system for 24 hours. This standby supply at the central station may consist of rechargeable batteries, a combination of a single-engine-driven generator (with a trained person on duty 24 hours a day) and 4-hour capacity rechargeable batteries, or multiple-engine-driven generators. The high level of system security and personnel response or central station service is most often employed by high-valued facilities, such as those commercial and industrial properties insured under the highly protected risk (HPR) property insurance plan. For this reason, central station systems are generally considered to be principally for property protection.

Central station systems may monitor fire alarms, supervisory signals, guard patrol tours, and trouble signals. One of the greatest values of signaling systems for central station service is their ability to supervise the availability of other fire protection systems, such as automatic sprinkler systems or special-hazard fire extinguishing systems. For example, the ability of a central station system to supervise the position of an automatic sprinkler system control valve adds significantly to the overall management capability of a building fire protection system.

Important and new to the 2010 NFPA 72 Code is a requirement for training of operators. All operators in the supervising station shall demonstrate competence in all tasks required of

them in Chapter 10 by one or more of the following:

1. Certified by the manufacturer of the receiving system or equipment or the alarm-monitoring automation system
2. Certified by an organization acceptable to the authority having jurisdiction
3. Licensed or certified by a state or local authority
4. Other training or certification approved by the authority having jurisdiction.

An example of an organization providing alarm monitoring operator training is the Central Station Alarm Association (CSAA)

### **Proprietary Supervising Station System**

The Proprietary Supervising Station fire alarm system is widely used in large commercial or industrial occupancies.

Signals transmitted over a Proprietary Supervising Station system are received and automatically and permanently recorded at a constantly attended Proprietary Supervising Station located either at the protected premises or at another location of the property owner. In very simplistic terms, a Proprietary Supervising Station system is a central station system with the central station located at the protected premises. However Proprietary Supervising Station supervising stations are not listed.

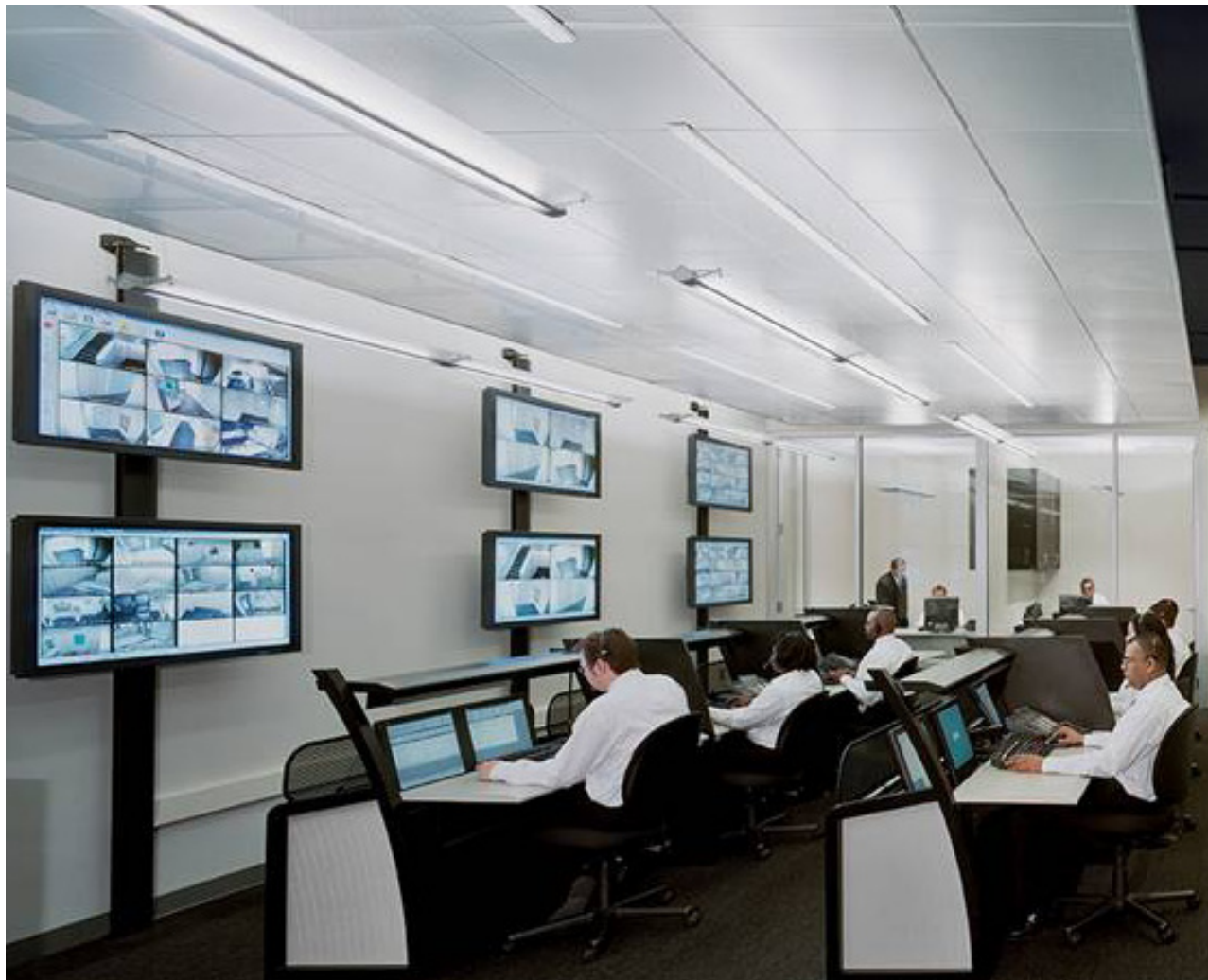

A modern central station service office

Many Proprietary Supervising Station systems have separate initiating device circuits for each building zone or subsection, similar to the protected premises, auxiliary, and Remote Supervising Station systems. Proprietary Supervising Station systems for larger buildings often have signal multiplexing and built-in micro-processor systems. These systems receive all signals from the building over one or more pairs of wires, and determine the exact location of the fire by use of different frequencies of digitally coded information transmitted over the conductors.

Large Proprietary Supervising Station Multiplex and computer-controlled systems usually do much more than indicate fire alarms to the operator and sound an alarm. These systems often provide for smoke control within the building by automatically closing and opening dampers in heating, ventilating, and air-conditioning (HVAC) systems and turning on exhaust fans. They also may adjust elevator controls so that elevators bypass fire floor and are automatically routed to the lobby floor for fire department use. The requirements for the systems and wiring within the protected premises are found within Chapter 23, Protected Premises Fire Alarm Systems.

In addition to increased flexibility, multiplexing signals greatly reduce the amount of wire used in a building. Computer-based-Proprietary Supervising Station system often includes energy management capabilities resulting in energy saving – a major factor in the recent sizeable increase in the use of these systems in large buildings.

Proprietary Supervision Station controls units are required to transmit alarm and trouble signals to the Proprietary Supervising Station. The control unit at the Proprietary Supervising Station, as well as remotely located control equipment, must have a secondary power supply

that will operate the system for a minimum of 24 hrs of normal signal traffic plus five minutes in alarm. Since operators are constantly on duty with a Proprietary Supervising Station system, 24 hrs of standby is considered sufficient.

### **Remote Supervising Station System**

A Remote Supervising Station fire alarm system has an alarm signal that is received at a remote location, acceptable to the authority having jurisdiction, which is attended by trained personnel 24 hours a day.

The receiving equipment usually is located at a public fire service communications center, police station, or telephone answering service. The signal is transmitted over a leased telephone line or by means of a digital alarm communicator system (DACS), and is indicated audibly and visually at the Remote Supervising Station. If the Remote Supervising Station is not at the public fire service communications center, the Remote Supervising Station personnel must notify the center of an alarm. System trouble signals usually are transmitted automatically to the remote receiving station. The control unit at the Remote Supervising Station, and, if needed, at the protected premises, also is required to have an independent secondary power supply that will operate the system for a minimum of 24 hrs, followed by 5 minutes of alarm. The protected premises of a Remote Supervising Station system may or may not have an evacuation system. Supervisory signals may be sent to the Remote Supervising Station receiving the alarm signal or the supervisory signals may be transmitted to a different Remote Supervising Station.

In the 2010 Edition of NFPA 72, a new and special provision allows three ways for Remote Supervising Station fire alarm systems to comply with the Code:

1. An affidavit attesting to the responsibilities and qualifications of the parties performing the inspection, testing and maintenance and accepting responsibility of compliance to the testing requirements of the Code.

2. Documentation indicating code compliance of the remote station fire alarm system issued by the organization that listed the service provider, such as UL, FM or ETL, and
3. Other documentation acceptable to the Authority Having Jurisdiction (AHJ).

### **Auxiliary Systems**

An auxiliary fire alarm system has circuitry that connects a building's fire alarm initiating device(s) to a public fire reporting system installed in accordance with the requirements of NFPA 72-2010 Chapter 27, Public Emergency Alarm Reporting Systems. This is done either through a nearby master fire alarm box, a dedicated telephone line run directly to the public fire communication center switchboard, or by long range radio

The signal received by the fire department is the same received when someone manually actuates the municipal fire alarm box. Because fire department personnel know which municipal boxes are part of the municipal system, responding fire fighters may be able to check for an alarm originating within the protected premises from an annunciator at the municipal box.

### **Codes and Standards**

In fire alarm installations there is more regulation than with the installation of other low voltage systems. This regulation takes the form as codes and standards.

In new construction, the building and/or fire code in force will reference the applicable NFPA standards and codes. Fire alarm system installations in existing buildings are often not exempt from building code requirements.

Depending on the state that the system is to be installed in, the building or fire code may require that a registered professional engineer,

qualified in the field, design and affix his or her engineering registration stamp to all design drawings.

In all cases, fire alarm systems must, be installed in compliance with the applicable requirement of the National Fire Alarm and Signaling Code NFPA 72, and the National Electrical Code NFPA 70. Many installers assume that when the customer only wants partial protection or cannot afford complete protection that the codes and standards do not have to be followed. In fire alarm systems installations, regardless of the amount of coverage intended, all devices and appliances still must be installed in compliance with the minimum requirements of the applicable codes and standards. NFPA 72-2010 mandates that all systems required by some other code or not, meet the requirements of the National Fire Alarm and Signaling Code.

### **The Building Codes and listed Central Station Service**

The Building code requirement many automatic fire alarm systems to be connected to a monitoring facility. This connection can be a central station, Proprietary Supervising Station or remote supervising station connection. In some jurisdictions, an auxiliary system connection is required. The point most often overlooked by both insurance and fire service professionals is that all of these monitoring connections must be installed in accordance with the reference NFPA code or standard. This means that the Remote Supervising Station connection point must be authorized by the local fire department. It also means that all central station connections must provide Listed Central Station Service as required by Chapter 26 of the 2010 edition National Fire Alarm and Signaling Code.

There are two primary model code organizations, the National Fire Protection Association (NFPA) and the International Code Conference (ICC).

<b>Requirement</b>	<b>Listed Central Station Service</b>	<b>Remote Station*</b>	<b>Auxiliary Fire Alarm</b>
24 hour personnel	Y	Y	Y
Constantly attended – 2 people	Y	N	N
Standby systems required	Y	N	N
HVAC system supplied by emergency generator	Y	N	N
Emergency lighting required	Y	N	Y
Restricted access to supervising station	Y	N	Y
Protected telephone lines	Y	N	N
“Class A” building construction or protected by automatic sprinkler system	Y	N	N
Premises fire alarm system service response required	4 Hours	N	N
Response to protected premises to reset fire alarm system	2 Hours	N	N
NRTL approved monitoring equipment	Y	N	N
“Threshold” requirements for supervising station equipment computerization	Y	N	N
Redundant equipment required at supervising station	Y	N	N
30 second switchover to redundant equipment at supervising station	Y	N	N
NRTL inspection of staffing	Y	N	N

*\* Where permitted by the authority having jurisdiction, alarm, supervisory, and trouble signals shall be permitted to be received at an alternate location approved by the authority having jurisdiction (AHJ). A listed central station might be considered an acceptable alternate location for receipt of fire alarm, supervisory, and trouble signals.*

The ICC was formed through the merging of three regional code making organizations:

- BOCA National Building Code, published by the Building Officials and Code Administrators (BOCA), is used primarily in the U.S. East of the Mississippi River.
- Standard Building Code, published by the Southern Building Code Congress International (SBCCI), is used primarily in the South and Southwestern United States.
- Uniform Building Code, published by the international Conference of Building Officials (ICBO), is primarily used in the U.S. West of the Mississippi River.

The ICC publishes the following model codes:

- International Building Code
- International Fire Code
- International Mechanical Code
- International Residential Code

The NFPA publishes the following model codes:

- NFPA 1 Fire Code
- NFPA 70 National Electrical Code
- NFPA 101 Life Safety Code
- NFPA 5000 Building Construction and Safety Code

The requirements for fire alarm systems in newly constructed or renovated buildings are contained in each of these model building codes. All new fire alarm systems are normally installed under a building permit that incorporates certain other requirements (designed by a professional engineer, stamped drawings, etc.).

A check with the authority having jurisdiction should be made prior to the start of a project to see which model codes have been adopted and the dates of the applicable editions. A check should also be made to see if any local amendments have been made to a particular model code.

## Fire Alarm Transmission Systems

### Methods of Alarm Transmission

Communications methods are defined in NFPA 72-2010 under 26.6.3 Communications Methods. There are four basic methods of alarm transmission from protected premises to a central station. These are Digital Alarm Communicator Transmitter (DACT), One Way Radio, Two Way Radio, and communications technologies not specifically mentioned such as packet data. Requirements such as supervisory and reporting times for these technologies are contained in the Code.

McCulloh, Active Multiplex Transmission Systems, including telephone-company-provided derived local channel system no longer appear in the latest version of NFPA 72.

A specific indication of the “sunset” of McCulloh systems was given in the 2002 Edition of NFPA 72, which reads as follows: “Unless accepted by the authority having jurisdiction, McCulloh systems shall not be permitted to be installed after June 30, 2003.” However, no such “sunset” requirement exists for Active Multiplex Transmission Systems, including telephone-company-provided derived local channel system.

A Tentative Interim Amendment, released concurrently with NFPA 72-2010 allows for Managed Facilities-based Voice Network (MFVN) to be used along with the PSTN. MFVN describes the service offered by cable companies and telecommunications companies where signals do not traverse over the public Internet.

The following is the definition of MFVN:

3.3.141 Managed Facilities-based Voice Network (MFVN). A physical facilities-based network capable of transmitting real time signals with formats unchanged that is managed, operated, and maintained by the

service provider to ensure service quality and reliability from the subscriber location to public switched telephone network (PSTN) interconnection points or other MFVN peer networks.

Heretofore, the Public Switched Telephone Network (PSTN) was the only telephone service that could be used with DACT. Managed Facilities-based Voice Network service is functionally equivalent to traditional PSTN-based services provided by authorized common carriers (public utility telephone companies) with respect to dialing, dial plan, call completion, carriage of signals and protocols, and loop voltage treatment and provides all of the following features:

1. A loop start telephone circuit service interface
2. Pathway reliability that is assured by proactive management, operation, and maintenance by the MFVN provider
3. 8 hours of standby power supply capacity for MFVN communications equipment either located at the protected premises or field deployed. Industry standards followed by the authorized common carriers (public utility telephone companies), and the other communications service providers that operate MFVNs, specifically engineer the selection of the size of the batteries, or other permanently located standby power source, in order to provide 8 hours of standby power with a reasonable degree of accuracy. Of course, over time, abnormal ambient conditions and battery aging can always have a potentially adverse effect on battery capacity. The MFVN field-deployed equipment typically monitors the condition of the

standby battery and signals potential battery failure to permit the communications service provider to take appropriate action.

4. 24 hours of standby power supply capacity for MFVN communications equipment located at the communication service provider's central office.
5. Installation of network equipment at the protected premises with safeguards to prevent unauthorized access to the equipment and its connections

When providing telephone service to a new customer, MFVN providers give notice to the telephone service subscriber of the need to have any connected alarm system tested by authorized fire alarm service personnel in accordance with Chapter 14 to make certain that all signal transmission features have remained operational. These features include the proper functioning of line seizure and the successful transmission of signals to the supervising station. In this way, the MFVN providers assist their new customers in complying with a testing procedure similar to that outlined in 26.2.3 for changes to providers of supervising station service.

Packet Data or Internet Protocol, IP, is not specifically mention in the Code. This is the use of packet data over either the public Internet or over a company's private data network. But the Code defines requirements that allow its use.

Among these requirements is the often misunderstood requirement regarding listing of on-premises equipment. The Code requires that all equipment is Listed. Most communications equipment, such as routers, are not specifically Listed for fire alarm applications, but are listed in accordance with applicable product standards for general communications.

Another provision of NFPA 72-2010 allows for two technologies, even if either one or the other (or both) is not specifically mentioned in the code, can be used. Where two

or more different technologies are used; the following requirements shall be met:

1. Provision shall be made to monitor the integrity of each communications path.
2. Failure of any communications path shall be annunciated at the supervising station and at the protected premises within not more than 24 hours of the failure.

Where technologies used are described elsewhere in this Code, monitoring for integrity shall be permitted to comply with those requirements.

Additionally, in residential systems, cellular can be used as the primary and only means of communications. Also, as in commercial systems, MFVN can be used to send an alarm system to a central station. This communications link is not required but, if used, can be any systems described in chapter 26 and, in addition, stand alone cellular.

---

## Equipment and Trained Personnel

NFPA 72- 2010 and the previous editions of the Code have several requirements regarding equipment, and the training of system designers, installers and monitoring personnel. These requirements are found in Section 4.4 of Chapter 10, Fundamentals

Equipment constructed and installed in conformity with this Code shall be listed for the purpose for which it is used.

System components shall be installed, tested, and maintained and monitored in accordance with the manufacturer's published instructions and this Code.

These requirements are shown in Chapter 10 of NFPA 72-2010.

---

## The Fire Alarm Certificate Service of Underwriters Laboratories Inc.

Underwriters Laboratories Inc. is chartered under the laws of the State of Delaware as a not-for-profit organization to “establish, maintain, and operate laboratories for the investigation of devices, systems and materials with respect to hazards affecting life and property.” The organization also promulgates standards for the operation and equipping of central stations and pursues a rigorous program of audits to confirm compliance with those standards.

Revenues come primarily from applicants who contract with UL to evaluate their products or services and to provide Follow-UP-Service.

UL’s field representative check on the means applicants use to provide continued compliance of products or services that bear the UL Mark and meet UL’s requirements.

### Background

In the early 1980’s UL established a program for the certification of fire alarm systems. Prior to this UL’s involvement with fire alarm systems mainly consisted of the testing of equipment such as detectors, control units, and notification appliances that would be installed in a system. A reported increase in fire alarm systems that did not comply with applicable NFPA standards prompted UL to develop a means of identifying code complying systems. The problems that were encountered included fire alarm equipment improperly installed or utilized and systems lacking periodic testing and maintenance. The program that was put into place had the purpose of enabling an Authority Having Jurisdiction

(AHJ) to identify through a UL certificate those fire alarm systems that not only have been installed but continue to be maintained in accordance with the National Fire Alarm and Signaling Code (NFPA 72-2010) or the standards that preceded NFPA 72.

The program that UL developed was patterned in part after its certificate service for burglar alarm systems, which has been in operation for almost 90 years. It involves the investigation of fire alarm service companies that apply for Listing. This process includes reviewing examples of fire alarm systems that have been installed to comply with NFPA standards and UL requirements. The names of companies that successfully complete these evaluation processes appear in UL’s On-line Certifications Directory under the category covering the type of alarm system involved. The company name also appears in the Underwriters Laboratories Certificate Verification Service (ULCVS) database, and in the CSAA member directory provided on-line at [www.csaaintl.org](http://www.csaaintl.org).

The main difference between the burglar and fire alarm programs is that the burglar alarm program was established to meet the needs of the insurance industry while the fire alarm program was designed to be used by any AHJ including both insurance and governmental authorities. In addition, flexibility was built into the fire program to permit special requirements or exceptions allowed by an AHJ for fire alarm systems in their jurisdiction to be shown on the front of the certificate and thereby be included in UL’s field inspection audits.

## Certificates

Certificates for fire alarm systems are available only from UL listed fire alarm service companies. The certificate is a declaration by the company responsible for its issuance that the system as described on the form has been installed and will be maintained in accordance with the NFPA standard referenced on the certificate. The testing and maintenance responsibilities extend for the life of the certificate unless the certificate is cancelled prior to its expiration date. Each certificate identifies the type of alarm system, shows the name and address of the property covered by the alarm system, and the name and address of the alarm company responsible for issuing the certificate. The type and amount of fire alarm equipment installed in the system is indicated together with the coverage provided by the equipment. Every certificate bears a unique serial number and issue and expiration date. The certificate cannot be issued for longer than five years. At that time, a new certificate would be issued.

The certificate is intended to provide to an authority having jurisdiction a high level of confidence that the fire alarm system is in compliance with the NFPA standards referenced on the form. For those cases where an AHJ's requirements for a fire alarm system differ from an NFPA standard, a system can still be covered by a UL certificate provided that the specific deviations are shown on the form.

## Inspections

One of the conditions of listing an alarm service company is that the company must subscribe to UL's Follow-Up Inspection Service and agree to periodic audits of its ability to offer certificated systems. As part of this process, UL conducts reviews of selected certificated systems to verify compliance with requirements. Any fire alarm system found not to be in compliance must be corrected within a specific time period or the certificate is subject to cancellation. Should this

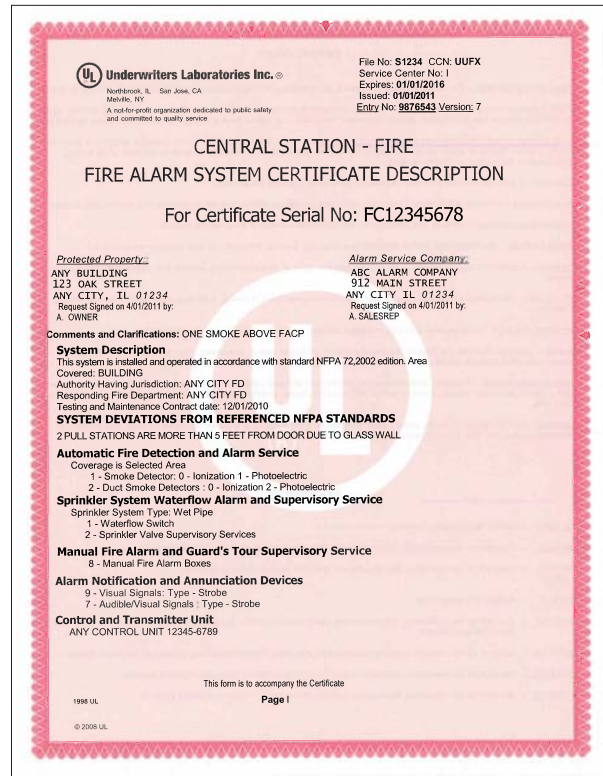

The image shows a UL Fire Certificate form for a central station fire alarm system. The form is titled "CENTRAL STATION - FIRE FIRE ALARM SYSTEM CERTIFICATE DESCRIPTION" and is for certificate serial number FC12345678. It includes fields for protected property (123 Oak Street, Any City, IL 01234) and alarm service company (ABC Alarm Company, 912 Main Street, Any City, IL 01234). The form lists system components such as smoke detectors, duct smoke detectors, and a wet pipe sprinkler system. It also includes a section for system deviations from NFPA standards, noting that two pull stations are more than 5 feet from the door due to glass walls. The form is dated 1998 UL and 2008 UL, and is page 1 of 1.

### UL Fire Certificate - Page 1

occur the certificate holder is notified by mail. The audit of fire alarm service companies and certificated systems are conducted by specially trained UL field representatives who are certified by the National Institute for the Certification of Engineering Technicians (NICET) for fire alarm systems.

## Listings

The Listing of alarm service companies in UL's On-line Certifications Directory (<http://www.ul.com/certifications>) involves the inclusion of central station companies in one category and alarm service companies responsible for protected premises, auxiliary, remote supervising station or proprietary supervising systems in another category. An alarm service company can only issue the type of fire alarm certificate that is covered by its Underwriters Laboratories evaluation and Listing. To qualify for Listing, a central station must meet the requirements in UL's Standard for Safety for "Central-Station



UL Fire Certificate - Page 2

Alarm Services” (UL827). This standard contains specific requirements for some of the most important features of a central station including central station building, fire protection, operations room security, alarm receiving and signal processing equipment, standby power, emergency lighting, telephone cable security, and central station staffing. A central station is checked for compliance with the standard by a specially trained UL field representative during the initial Listing process and also during regular annual audits.

UL approved central station alarm companies have the capability of providing full service. This is generally recognized as including not only monitoring, retransmission of signals and record keeping but also responsibility for the alarm system at the protected area including equipment installation, inspection, testing, maintenance and runner service.

**ONLY THOSE ALARM SYSTEMS THAT HAVE AN ACTIVE CERTIFICATE ARE**

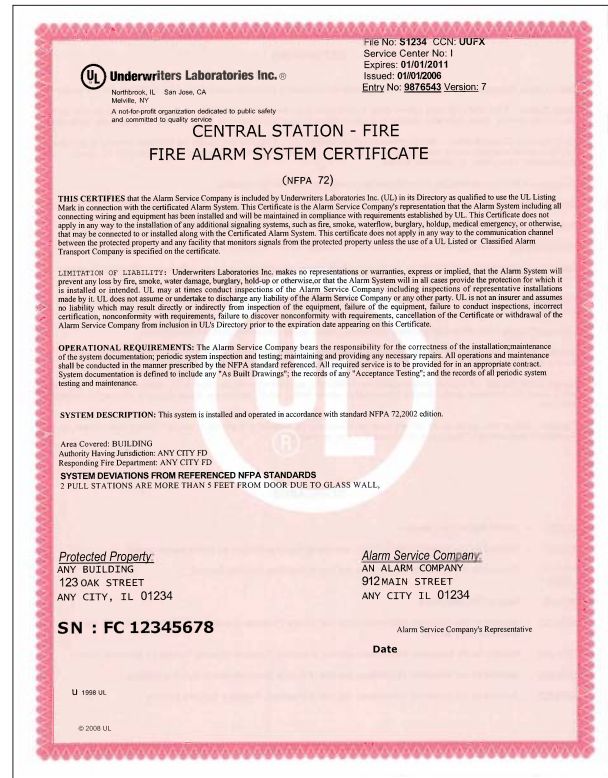

UL Fire Certificate - Page 3

**CONSIDERED TO BE UL LISTED AND ARE COVERED BY ITS FOLLOW-UP SERVICE PROGRAM**

For central station alarm companies, the Listing identifies the city or cities from which central station service is available. Certificated central station service is generally not available more than two-hour travel time from the central station response center.

### Required Services

In recent years economic and competitive pressure have resulted in services provided by fire alarm service companies for many fire alarm systems to be unbundled. Examples include systems provided with the installation of proper equipment but lacking periodic testing or maintenance. Additional examples include systems monitored at a central station but missing other essential central station services such as inspecting, testing, and runner service. These types of systems cannot be issued a UL certificate. Only

those systems that are provided with all elements of service required by the NFPA 72-2010, National Fire Alarm and Signaling Code® are eligible for certification.

## **Underwriters Laboratories Certificate Certification Service (ULCVS)**

To provide an AHJ with a means of identifying UL-Certificated fire alarm systems that are currently covered under its Listing and Follow-Up Services, UL developed the Underwriters Laboratories Certificate Verification Service (ULCVS). By directly accessing the certificate database, an AHJ can verify whether a valid fire alarm certificate has been issued or is in effect. To use ULCVS, an AHJ must have a computer with access to the Internet. The AHJ must subscribe to and receive authorization from UL to use ULCVS. Access to the database is password protected. There is no charge to the AHJ by UL to use the system. When logged-on to the service, an AHJ will be able to search the database by certificate number to find the status of a certificate. Searches by name and location also can be performed. Also the database allows the identification of all alarm service companies qualified to issue a specific type of certificate. The inquiry can be made by city or state allowing the search to be localized to a particular geographical area. Future improvements in the database will permit the service territory served by a specific company to be shown by zip code. This means that if the zip code of an account is entered into the system, a list of all qualified alarm service companies providing service to that area will be able to be obtained.

### **Benefits of ULCVS**

It is in the interest of an AHJ to subscribe to ULCVS since several benefits can be obtained from its use. Among these are:

1. The reliability of the information available on the database. An AHJ does not have to depend on the information provided by the protected property owner or Alarm Service Company to determine the status of a UL-Certificated system.
2. If a UL-Certificated alarm system is a condition of occupancy, an AHJ will be able to find out, the date that the alarm system will be in service.
3. An AHJ can determine whether an alarm system still has a valid certificate at anytime.
4. There is no cost to an AHJ for this service. The only requirement is to have Internet access.

More information about ULCVS and how to subscribe may be found at <http://www.ul.com/alarmsystems>.

### **Certificate Reports**

Authorities Having Jurisdictions may now access information regarding listed systems within their jurisdictions via a web based application. In order to take advantage of this service, the jurisdiction in question has to be definable by specifying Zip Codes.

Available reports include:

1. A copy of each new certificate issued in the jurisdiction,
2. A copy of any cancellation or expiration notices sent to protected properties in the jurisdiction, and
3. A list of active certificates in the jurisdiction sorted by zip code, street address or protected property name.

AHJs interested in subscribing to this service can call UL at 847 664 9471 or write to the address shown above. They may also sign up for the service through the UL web portal at [www.ul.com](http://www.ul.com).

## UL Procedures for Issuing Certificates

UL certificates may be created in two ways – the traditional method which relies a five step process that is based on the submittal of forms by mail or FAX, and an on-line method known as ULwebCert that was introduced in 2011. While there are no plans to abandon the traditional method in the foreseeable future, the on-line process provides alarm service companies timely processing and greater control over this important operation.

To utilize ULwebCert an alarm service company must establish an account at UL's secure customer portal - MyHome@ul. The process requires an individual at the alarm service company to be designated as a gatekeeper. Once that is done anyone within the company can initiate the process of creating certificates or accessing certificate records. However all such actions are sent to the gatekeeper for approval or rejection. Security is also assured by secured 128-bit encryption SSL connections. The system offers the advantage of access at any time, on-line "smart forms" that only display valid protection detail choices, automatic checking on service territory requirements, and errors or omissions are flagged for correction before the request is transmitted to UL. The system also provides an email acknowledgement when the certificate is processed and the ability to print a receipt that can be provided to an AHJ as evidence that a certificate has been created. Logging on to ULwebCert also provides alerts for certificates that are due to expire within 60 days and supports easy search and filter tools to better manage certificate inventories and alarm customer information. For more information, or to register at MyHome@UL simply log on to UL's web site at <http://ul.com>.

The traditional method for issuing of certificates involves the following five steps:

1. The Alarm Service Company completes a "Request for Certificate" form, which must be signed by the subscriber, and sends it to UL. Accompanying the request is an "Alarm System Description" form, which provides all relevant information about the alarm system.
2. UL reviews the request and verifies that it is correct. After reviews, each correct request is entered into the database (ULCVS). Improperly completed requests will result in either a telephone call to the Alarm Service Company, or, if the problem cannot be corrected over the phone, the request will be returned to the Alarm Service Company.
3. Once entered into the database, a uniquely numbered certificate will be individually printed and sent to the Alarm Service Company.
4. The Alarm Service Company reviews the certificate for accuracy, signs it and sends it to the subscriber.
5. In order to accommodate those special situations where a subscriber may have immediate need of a certificate to satisfy insurance programs a FAX program is provided. In this scenario, a certificate number is provided to the Alarm Service Company and entered into the database (ULCVS) in a "Pending" status.

The certificate number, which is randomly generated by UL, becomes the most important element in the program. The actual certificate is intended only as confirmation of the information in the database.

### Additional Information

Additional detailed information about the UL Fire Alarm Certificate Program, including program updates, can be found in UL's website: <http://www.ul.com/alarmsystems>.

## Factory Mutual Research Corporation (FMRC) Approval Process

Factory Mutual Research Corporation (FMRC) was formed in 1941 and is an internationally recognized testing laboratory. Factory Mutual Research currently lists over forty thousand products and services, provided by nearly twenty-five hundred companies.

Factory Mutual Research accepts equipment, materials and services for approvals testing based upon two general principles.

1. They must be useful to the ends of property conservation by preventing, limiting, or not causing damage under the conditions of the approval.
2. They must be readily identifiable and available in the marketplace.

Once accepted for testing, equipment, materials and services receive Factory Mutual Research Approval and listing subject to meeting the stated conditions of performance, safety and quality.

Third party certification demonstrates that a manufacturer has complied with a recognized standard; it also assures a product user that the manufacturer's on-going production or service will continue to be monitored by FMRC for compliance with approval requirements.

### Factory Mutual Approval Guide

A prospective buyer deciding between an Approved product or service, or a non-Approved product or service knows the Approved product or service has been tested by an independent and nationally recognized laboratory. The buyer also knows the product or service conforms to certain requirements and can be expected to continue to meet those conditions.

All Products which meet FMRC requirements are listed in the Approval Guide or the Specification Tested Products Guide. These products and services have been subject to examinations and inspections and have been found to satisfy the criteria for approval. These examinations and inspections are performed by Factory Mutual technicians and engineers according to Factory Mutual requirements or recognized national and international requirements. Listed products are readily identifiable and available on the market.

Continuance of Approval depends on satisfactory performance in the field. Periodic reexaminations of equipment, materials, and services and follow-up inspections of the manufacturing facility or service are parts of the Approval. Also as a condition of retaining Approval, manufacturers may not change a product or service without prior authorization by FMRC. Unless covered by agreements executed between the manufacturer and Factory Mutual, Approved products should not be altered or otherwise modified during or after installation. Unauthorized alterations or modifications may impact on the safety and performance of the product and will void the Approval.

Most FMRC Approved products will bear one of the marks shown below. Only companies providing Approved products or services may use these marks on the products or in their literature

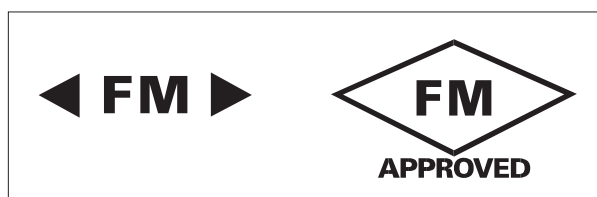

FM Approval Marks

or advertising. The marks may only be used for the specific product or services Approved.

### **Factory Mutual Central Station Approval**

Approved central station companies have the capability to install, operate, test and maintain electrical signaling equipment in conformance with FMRC Approval Standard 3011 and NFPA 72 for the purpose of fire protection at subscribing customer properties. The customer-located equipment communicates with a constantly attended central station where alarm, supervisory, trouble and test signals are received and acted upon. “Standard” central station service for a highly protected risk (HPR) consists of codes- and standards-complying central station service covering the following “standard” protection features:

Fire Alarm signals from –

- At least one manual fire alarm box
- Sprinkler waterflow for all sprinkler systems
- Discharge from all special hazard extinguishing systems including kitchen range hood systems
- Automatic fire alarm systems installed in all non-sprinkler-protected areas where incidental combustibles might be temporarily present
- All other fire alarm system control units installed at the premises

Supervisory signals consisting of –

- Valve temper for all sprinkler system control valves 2 1/2 inches or larger, for all water supply control valves, including divisional valves, pit valves, incoming supply valves, fire pump valves and water tank valves
- High and low air pressure for all dry pipe automatic sprinkler systems and water pressure tanks

- Low water level for water pressure tanks, gravity tanks, and fire pump suction tanks
- Low tank temperature for water pressure tanks, gravity tanks and fire pump suction tanks located in areas subject to freezing temperatures.
- Low building temperature for all buildings protected by wet pipe automatic sprinklers when located in areas subject to freezing temperatures, for fire pump rooms located in areas subject to freezing temperatures, and for all dry pipe valve closets, preaction valve closets or deluge valve closets where the closets have been installed to provide protection against freezing.
- Fire pump running for all fire pumps
- Fire pump loss of power and phase reversal for electric motor-driven fire pumps
- Fire pump controller main switch in position other than automatic, trouble with fire pump and controller, battery charger failure for diesel engine-driven fire pumps
- Low steam pressure for steam engine-driven fire pumps
- Low public water pressure when connection is located on a dead-end main or when public water is considered to be unreliable.
- Supervisory and trouble conditions from all other fire alarm system control units installed on the premises.

Codes- and standards-complying central station service means an implementation of central station service that fully meet the requirements of ANSI/UL 827, FMRC 3011 and NFPA 72. This means that “standard” central station service will either be UL-certificated or FMRC-placarded.

Although other levels of alarm service are available from these companies, when standard service is contracted for the procedures, equipment, power supplies, record keeping and testing by central station personnel can be expected to result in highly reliable performance by the fire alarm system.

Standard service usually is provided only if specifically contracted for by the customer. Customer installations that are not marked by the central station as receiving standard service should be presumed to be non-standard.

Standard service also may be jointly provided if done so under a single contract with the customer: the contracting entity must be either an Approved Central Station Company or an Approved Fire Alarm Service-Local Company, or an Approved Central Station – Monitoring Only Company. The central station company receives, interprets, acts on and maintains record of signals originating from the subscribing property but subcontracts some or all of the other required activities; alternatively, if the standard service contracting entity is an Approved Fire Alarm Service-Local Company, it may subcontract, to an Approved Central Station Company or an Approved Monitoring Only Company, the signal monitoring and other required activities, including runner service. Unless designated as a Fire Alarm Service-Local Company or a Monitoring Only Company, the company is capable of providing standard service in its entirety.

To assure prompt inspection, maintenance and equipment repair, approval is limited to the area within 4 hours travel time (200 mi.; 320 km) of the location from which maintenance and repair personnel are dispatched. Approval is further limited to the area within 2 hour travel time (50 mi.; 80 km) of the location(s) from which personnel are dispatched to reset fire alarm equipment at the protected premises (if necessary) and to investigate supervisory or trouble signals.

### **Factory Mutual Approved Central Station – Monitoring Only Companies**

Approved Central Station monitoring only companies contract to provide central station service in accordance with FMRC Standard 3011 and NFPA 72 by monitoring, retransmission, associated record keeping and reporting of signals received with their own personnel and subcontracting the installation, maintenance and testing services to an Approved Fire Alarm Service – Local Company. The required runner service may be provided by either the Approved Central Station – Monitoring Only Company with its own personnel or by the Approved Fire Alarm Service – Local Company with its personnel.

The Monitoring Only Company, acting as prime contractor has the responsibility of the monitoring, retransmission, associated record keeping and reporting of signals. It is also their responsibility to ensure that the installation and equipment contains the proper compliance markings according to the requirements of FMRC Standard 3011 and NFPA 72.

### **Factory Mutual Approved Fire Alarm Service – Local Companies**

Approved local companies contract to provide central station service for fire reporting in accordance with FMRC 3011 and NFPA 72 by doing the installation, maintenance and testing services with their own personnel and subcontracting the monitoring, retransmission, associated record keeping, and reporting of signals to an Approved Central Station Company. The required runner service may be provided by either the Approved Central Station Company with its own personnel or the Approved Fire Alarm Service – Local Company with its own personnel.

The Local Company acting as prime contractor has the responsibility of ensuring that the installation is inspected, tested, repaired and maintained and also that it contains the proper compliance markings in accordance with the requirements of FMRC 3011 and NFPA 72.

# ETL Listed Alarm System Certification Program

## About Intertek

The ETL Listed Alarm System Certification Program ensures safety in commercial and residential facilities across North America.

Intertek's ETL Alarm System Certification Program has been constructed following the requirements of the Occupational Health and Safety Administrations (OSHA) and by utilizing the applicable standards by organizations such as the NFPA and UL for inspection and auditing parameters.

## Background

Intertek's ETL Listed Alarm System Certification Program has been established to assist the Fire and Security Industries in their efforts to implement and maintain high levels of alarm system reliability. The program assures AHJ's that the alarm system has been installed, is being maintained and, participates in annual independent third party surveillance by a Nationally Recognized Testing Laboratory (NRTL) to ensure full compliance with all federal, national and local standards and codes.

Participation in this program permits the freedom to choose any products or components tested and certified by a nationally recognized testing laboratory, differentiation from the

Intertek offers two solutions in this program:

### 1. File conversion or Dual Listing

When a central station or alarm service company is currently listed with another NRTL, Intertek, following the OSHA NRTL

program guidelines, has the ability to review the current certificate and approved scope of work, verify the alarm service company is in good standing with the current NRTL, and proceed with the issuance of an Intertek-ETL Approval. This allows the alarm service company to issue Intertek-ETL certificates to the premises owner and the responsible AHJ's. Intertek will conduct the conversion and dual listing process free of charge for companies that meet these criteria.

### 2. New Client Certification

Intertek also provides an avenue for un-listed alarm service companies to determine compliance with all federal, national and local standards and codes. The alarm service company will be audited and reviewed against these standards and once compliance has been determined to these codes, the alarm service company will have the ability to issue Intertek – ETL Certificates to the premises owner and the responsible AHJ's.

## Certificates

ETL Listed Certificates are a declaration by the company responsible for its issuance that the system as described on the form has been installed and will be maintained in accordance with the NFPA standard referenced on the certificate. The testing and maintenance responsibilities extend for the life of the certificate unless the certificate is cancelled prior to its expiration date. Each certificate identifies the type of alarm system, shows the name and address of the property covered by the alarm system, and the name and address of the alarm company responsible

for issuing the certificate. The type and amount of fire alarm equipment installed in the system is indicated together with the coverage provided by the equipment.

The certificate is intended to provide to an authority having jurisdiction a high level of confidence that the fire alarm system is in compliance with the NFPA standards referenced on the form.

## Inspections

Once an alarm service company has established a Listing (regardless as to whether the listing is a dual listing or a new listing), they will be subject to annual audits by Intertek Alarm System Auditors.

The auditor will randomly select premises where installations have occurred within the past year. Coordination between the Alarm Service Company and the premises will be important to allow for a joint walk through and inspection that ensures the systems are in effective compliance with the code requirements, and all systems documentation is in order.

Once the field inspections have been completed, the Intertek Alarm Auditor will release a report of findings within 5 business days. This summary will outline any deficiencies or observations identified during the inspections and provide a timeline for resolution. Upon successful completion, Intertek will release a revised certificate of compliance.

## Intertek's Alarm Service Company Database, "My Test Central"

To provide an AHJ with the means of identifying an ETL Listed Alarm System Company, all ETL Listed Central Stations and Alarm Service Companies will have the ability to access Intertek's proprietary My Test Central for Alarm Service Companies database, which will allow the alarm service provider to generate a temporary certificate, with a two week expiration, that can be previewed, printed and handed to an AHJ on the spot.

Intertek's Alarm Service Program Manager will conduct a formal review and verify the qualifications of the service provider against the temporary certificate, and release the formal certificate within two (2) weeks. Once this Certificate has been made official, it will be posted on Intertek's proprietary My Test Central for Alarm Service Companies database, available anytime.

## Additional Information

Additional detailed information about Intertek's ETL Listed Alarm System Certification Program can be found on Intertek's website: <http://www.intertek.com/life-safety>

## Residential Fire Alarm Systems

Eighty percent of all fire deaths in the United States occur in the home (Source: NFPA). As stated in NFPA 72, “It is estimated that each household will experience three (usually unreported) fires per decade and two fires serious enough to report to a fire department per lifetime.” Because of these facts, smoke alarms have been required in dwelling units for a number of years. . In addition, there is more fire safety awareness by the homeowner who wants to provide more fire detection than “code minimums.” Chapter 29, Household Fire Warning Systems, of the 2010 edition of the National Fire Alarm and Signaling Code covers the minimum requirements for the installation of smoke alarms or system-connected smoke detectors and the recommendations for additional protection.

Because life safety protection from fire in residential occupancies is based on early notification to occupants of a fire condition, it is imperative that the number of smoke detectors and notification appliances be sufficient to both detect and awake the occupants of the home. Chapter 29 of the 2010 edition of NFPA 72 requires that in all new construction, a smoke alarm be placed in each bedroom, in the hallway outside of each bedroom area and on each level of a home. These devices are required to be interconnected (multiple-station smoke alarms) so that if one device actuates, all alarm notification appliances in each smoke alarm will operate.

There is some confusion as to what constitutes a fire alarm “system” in residential fire detection. The multiple-station smoke alarms that are required by NFPA 72, Chapter 29, are not considered a fire alarm system.

A residential fire alarm system consists of smoke and heat detection devices and notification appli-

ances connected to a control unit (panel). Many time an installer or alarm company salesperson will “sell” add-on fire detection, typically a smoke detector or two, when selling a security alarm system. Combination fire/security systems are allowed by NFPA 72; however, one must ensure that proper detection coverage in accordance with 29 of the National Fire Alarm and Signaling Code is provided.

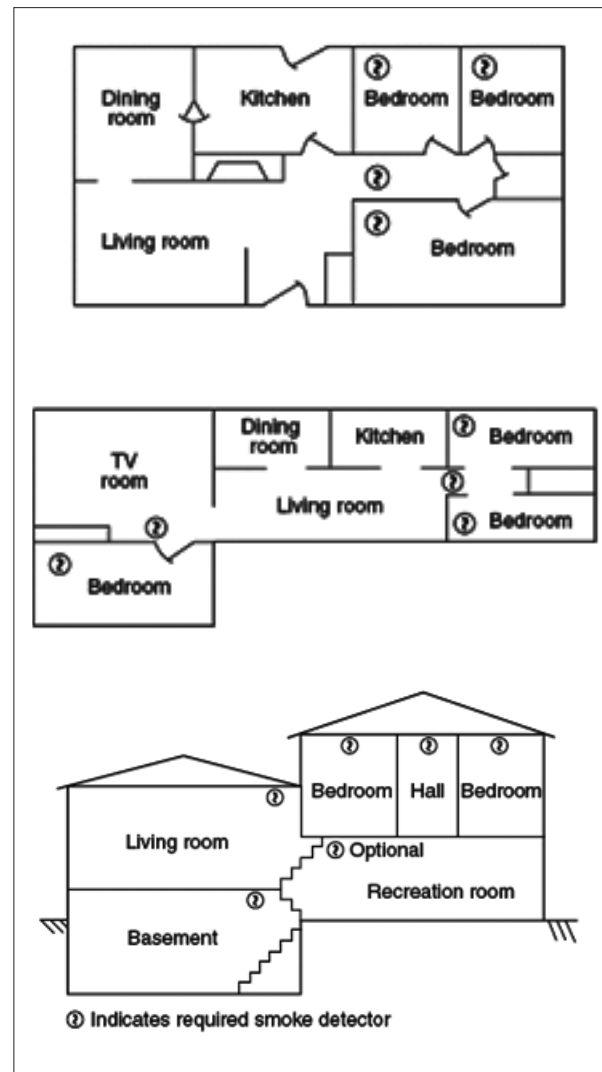

Sample House Blueprint

It is good practice when providing a fire alarm system or a combination fire/security system, to add heat detection coverage in areas such as attics, laundry rooms, kitchens, near heating and electrical equipment and in garages.

Some of the requirements for commercial fire alarms systems have been relaxed for residential fire alarms systems. For instance, when monitoring is employed, only one telephone line is required for Digital Alarm Communicator Transmitters (DACT) when connecting the residential system to a UL Listed monitoring company and a test to the monitoring central station need only be generated once per month. However, wiring requirements in accordance with the National Electrical Code and NFPA 72 must still be followed.

In order to minimize false alarms from smoke detectors, ensure that these detectors are located away from bathrooms and kitchens. It is also important to advise the homeowner that regular cleaning of the smoke detectors is required to ensure smoke detector stability. Although either type of smoke detector, photoelectric or ionization, are allowed in a residential application, photoelectric smoke detectors are the better choice. The photoelectric smoke detector is less prone to false alarms caused by cooking gases and, therefore, is more stable.

NFPA 72-2010, Chapter 29 requires that smoke alarms and smoke detectors shall not be installed within an area of exclusion determined by a 10 ft. (3.0 m) radial distance along a horizontal flow path from a stationary or fixed cooking appliance, unless listed for installation in close proximity to cooking appliances.

Smoke alarms and smoke detectors installed between 10 ft. (3.0 m) and 20 ft. (6.1 m) along a horizontal flow path from a stationary or fixed cooking appliance shall be equipped with an alarm-silencing means or use photoelectric detection.

However, smoke alarms or smoke detectors that use photoelectric detection shall be permitted for installation at a radial distance greater than 6 ft. (1.8 m) from any stationary or fixed cooking appliance when the certain conditions are met as described in the Code.

Additionally a dedicated cellular telephone connection shall be permitted to be used as a single means to transmit alarms to a constantly attended remote monitoring location.

Household fire alarm systems shall be programmed by the manufacturer to generate at least a monthly test of the communication or transmission means.

Another change to household fire alarm systems according to the requirements of Chapter 14 Table 14.4.2.2, requires that these systems be tested by a qualified service technician at least annually

## Fire Detection to Comply with Insurance Requirements

Many small businesses such as a warehouse, small manufacturing facility, restaurant, gift shop, or other mercantile business will be required by their local insurance agent (hereinafter called the insurance provider) to “install a fire alarm system” as a condition of obtaining or keeping insurance on their property. The owner then relays this information to a central station or alarm installation company and bids are solicited. The major problem here is what is meant by “install a fire alarm system?”

The owner expects that the insurance agent will provide specific guidance regarding fire alarm system design. However, many insurance providers do not have access to an engineering department. Therefore it is imperative that the insurance provider reading this guide be aware of the proper questions to ask.

Some of the questions which should be directed to the company that the insurance broker plans to have write the insurance policy include the following:

- What is the purpose of the fire alarm system?
- What is the primary goal of the fire alarm system (i.e., property protection, mission continuity)?
- What are the design characteristics of the fire alarm system?

Generally the reason a fire alarm system is requested is to attempt to reduce potential property damage from fire. This criterion alone will eliminate the option of a manual, protected premises fire alarm system from being accepted.

In order for a fire alarm system to be of any value to the insurance company, or the owner of the property, it must be automatic and monitored by an acceptable off-premises monitoring facility. To ensure reliability of both the fire alarm system and the monitoring connection, central station service is highly recommended.

In addition, most building codes require that once a fire alarm system is to be installed, it must follow the building code’s minimum requirements as well as the requirements of NFPA 72. In any case, the insurance provider should be more explicit when asking for a fire alarm system.

As stated in prior sections of this guide, any fire alarm system must be installed in accordance with NFPA 72, National Fire Alarm and Signaling Code, even if the insurance provider allows “partial protection”. (For more information regarding property protection and partial protection, see section 1 of this guide.) The insurance provider is encouraged to always ask for the “Record of Completion” as required by NFPA 72.

The insurance provider should recommend that the authority having jurisdiction (AHJ) be consulted before requesting fire alarm system designs, quotations or installation. In most instances, the AHJ will be the fire service professional or the building official in conjunction with the fire service professional.

The insurance provider should also caution the owner to not simply call everyone listed in the “Yellow Pages” under the listing of “alarm installer”, but to first have the fire alarm system

designed by a competent engineer experienced in the field of fire alarm systems. The qualifications of the installing company are extremely important and the insurance provider would be well advised to recommend that the owner obtain a quote from the listed central station serving the area.

When bids are obtained, it should be cautioned that the lowest bid may be for a design that is the least protection for the owner. If the insurance provider does not offer the guidance needed in this early phase of fire alarm system evaluation, the owner and the insurance provider will not get a fire alarm system that will meet their respective requirements.

## Highly Protected Risk (HPR) Fire Protection and Surveillance

The minimum fire protection and security surveillance which is satisfactory to an HPR insurance carrier is dependent on property values and risk characteristics. The protection provided is the basis for developing loss prevention recommendations. Surveillance is intended to address the normal and catastrophic loss exposure, which takes into consideration property damage and business interruption values, special hazards and damageability of contents.

HPR insurance companies defines “alarm service” as one which is NRTL certificated and installed in accordance with the provisions of the appropriate sections of NFPA 72 for Central Station, Proprietary Supervising Station (with some restrictions), Remote Supervising Station or Auxiliary.

“Complete alarm and supervisory service” is defined as a central station, Proprietary Supervising Station, Remote Supervising Station, or a combination auxiliary (for alarms)/ Remote Supervising Station (for supervisory) fire alarm system, with the requirement that the fire alarm system must be UL Certificated or FMRC placarded for a new installation or an extension to an existing installation, and installed in accordance with the National Fire Alarm and Signaling Code covering.

- Fire alarm signals from the discharge of all automatic sprinkler and other extinguishing systems. Fire alarm signals from all installed automatic detection systems. Fire alarm signals from at least one manual fire alarm box.
- Supervisory signals from the closure of all fire protection water supply, divisional and sprinkler system control valves 2 ½ inches or larger.
- Supervisory signals, which monitor the high and low air pressure of all dry pipe sprinkler valves.
- Supervisory signals which monitor the integrity of all private water supplies, including storage tank level and low temperature (in areas subject to freezing temperatures), fire pump running and driver/controller availability.
  - For electric motor-driven fire pumps, pump running, power availability, and phase reversal must be monitored for supervisory condition.
  - For diesel engine-driven fire pumps, pump running, engine or controller trouble, and controller switch in position other than “automatic” must be monitored for supervisory condition.
  - For automatic steam driven pumps, pump running and steam availability must be monitored for supervisory condition.
- Supervisory signals which monitor the low pressure of all questionable public water supplies.
- Supervisory signals which monitor the low temperature of all buildings equipped with wet pipe sprinkler systems, all dry pipe sprinkler valve closets and all fire pump rooms (in areas subject to freezing temperatures).
- Supervisory signals which monitor safe operating parameters of critical processes as a backup to the operating controls, such as excess pressure or increased temperature, or which monitor external conditions which

might affect the safe operation of a process, such as flooding of an oil pumping pit. The provision of these process monitoring supervisory signals will usually result from information determined during implementation of a facility's hazard identification program.

Generally when an HPR insurance company is involved at a facility, the local fire officials will find all fire protection systems more consistently in compliance with the national fire codes. The requirement of UL, ETL Listed or FMRC approved central station service provides a higher level of monitoring than that required by some jurisdictions.

---

## Special Appliance for Fire Protection

### Combination Systems

Fire alarm systems are often combined with or interfaced with other systems in a building. Examples of typical combination systems include fire alarm/security alarm systems and building management/fire alarm systems. The National Fire Alarm and Signaling Code allows combination systems only if the fire alarm system operation is not compromised by the system combined with it, and if the fire alarm system signals will take precedence.

### Special Hazard Systems

Connecting carbon monoxide detectors to a fire alarm system is permitted by NFPA 72 and 720, Standard for the Installation of Carbon Monoxide (CO) Detection and Warning Equipment. These detectors are primarily used as a local warning to the occupants. If a carbon monoxide detector is connected to and monitored by a central station, the operators should be trained to provide special instructions to be subscriber to vent the area involved and to see medical assistance.

Natural gas detection is another common form of non-fire detection that may be installed in a property that has heating or processing equipment that is gas-fired. Again, this form of detection should not be connected to the fire alarm system. Rather, the central station should monitor it as a “supervisory signal” to provide the subscriber and gas utility company with the appropriate information.

Some property owners will demand some form of water leak/flood detection for buildings that contain pipes that might break or processes that might overflow and are not occupied on a 24-hour basis. Again, this detection is for the owner’s benefit only and not to be connected to activate a fire alarm.

Many buildings will have special hazard protection systems installed in addition to the fire alarm system. These special hazard systems may include fire extinguishing or suppression systems for a variety of hazards, such as computer rooms or kitchen hoods. In all cases, when a fire alarm system is installed in a building, these special hazard systems must be connected to the fire alarm system. Each special hazard system must be monitored for alarm, trouble and supervisory. The supervisory monitoring requires that if the special hazard system malfunctions in any way (i.e., loss of power, any trouble condition, etc.), that malfunction must be individually identified and reported as a supervisory signal at the fire alarm system.

### Automatic Sprinkler Systems Interface with Fire Alarm Systems

An automatic sprinkler system must be connected as a separate point or zone on the fire alarm system in the facility. If there is no fire alarm system in the building, a manual fire alarm box must be installed (location determined by the AHJ). This box may be used to notify the central station of a fire when the automatic sprinkler system is shut off for maintenance. Normally a waterflow alarm-initiating device is used



Supervisory Switch

to connect the automatic sprinkler system to the fire alarm system. A waterflow switch may be a pressure type switch or vane type switch (see photo below and drawing on following page).

The control valve is monitored for off-normal position. This function is normally served through the use of a valve supervisory switch. This device must also report separately as a supervisory signal (not a trouble signal) at the fire alarm control unit.



Waterflow Vane Switch



Waterflow Switch

## Maintaining Fire Alarm System Reliability

During the last twenty years, fire alarm systems have evolved from traditional relay-based control equipment to microcomputer-based technology. A decade ago, the limiting factor for a reliable fire alarm system was usually the hardware. To provide flexibility, new systems were designed with modular components, all of which were potential sources of failure. Today, however, microprocessor-based systems produced in modern facilities employing modern quality assurance techniques for both hardware and software attain, and often exceed, their theoretical reliability. Because of this theoretical high reliability, we have been lulled into thinking that total system reliability is only a function of the hardware's reliability.

Yet after two decades of improvements in fire alarm equipment, reliability problems persist. Why? Because the improvements in equipment mean nothing if they are not accompanied by improvements in design, installation, testing and maintenance.

For our purposes, "reliability" is the measure of the likelihood that a fire alarm system will respond appropriately to the conditions that occur during its lifetime. Because fire alarm systems installations do not follow the strict rules of reliability calculations, the term "mission effectiveness" is a better term to define the system's overall quality. Mission effectiveness combines equipment reliability with software reliability, installation quality, and testing and maintenance effectiveness.

As previously stated, manufacturers have stressed quality control and have made every effort to improve the reliability of fire alarm system equipment. However, even a manufacturer's most ardent efforts can only have limited effect

on the reliability of an installed system. Why? Because the equipment – the hardware and the software – make up just one of the four principal elements of a system: equipment, system design, system installation, and system maintenance.

The best system design, implemented with the finest equipment available can still be unreliable if it is not installed properly. The purpose of this guide is to assist insurance and fire service professionals in their understanding of the components and operations of fire alarm systems and what effects they have in increasing the reliability of installed systems. Diligence in reviewing the design, installation and, equally as important, the testing and maintenance of the fire alarm systems will help achieve the reliability goal.

If the fire service or insurance professional is unfamiliar with the installed fire alarm system, he or she should seek out a qualified third party to assist with the evaluation of both the system design and the installation. Creating a checklist will prove useful. A good starting point for a checklist would be the requirements of NFPA 72-2010, Chapter 14 and the related Appendix material.

### Testing Requirements

Every fire alarm system must be 100% acceptance tested. How else will you know it "works"?

After a fire alarm system is first installed, A Record of Completion, found in NFPA 72, Chapter 10, must be completed for each system installed. (Multiple station 120 VAC smoke alarms are not considered a system). This form may be copied from NFPA 72.

The area of acceptance testing is where insurance and fire service professionals can have the greatest impact on the mission effectiveness of the installed fire alarm system. Because the insurance and fire service professional cannot possibly stay abreast of the continuous changes in fire alarm system technology, they should always ask for the Record of Completion, a complete operational description of the fire alarm system, and, in the case of a central station system, a copy of the UL certificate or the FMRC placard prior to scheduling an initial acceptance test. By reviewing these documents, the acceptance test protocol or plan can be developed before the acceptance test is conducted.

The National Fire Alarm and Signaling Code Chapter 14 requires “as-built” or “record” drawings. These drawings consist of a plan of the building showing the exact location of all devices and appliances, lines drawn from device to device and appliance to appliance showing how the fire alarm contractor actually installed the wiring, with indications on these lines showing the number of conductors, circuit identification, and location of all junction boxes. The insurance or fire service professional must demand to see these drawings prior to beginning the acceptance test.

Insurance and fire service professionals should require that the installer pre-acceptance test each fire alarm system and submit the Record of Completion prior to calling for the formal acceptance test. After all tests have been completed and all documentation of testing and system information has been submitted, the insurance and fire service professional can witness the final inspection acceptance test.

Chapter 14 of the National Fire Alarm and Signaling Code also details the initial acceptance tests, the reacceptance tests, the visual inspection, the periodic tests and the routine maintenance of the detectors and all other fire alarm system components. When witnessing the acceptance testing of a system, the insurance and

fire service professionals should require the fire alarm contractor to complete a test report similar to the one shown in Chapter 14 of NFPA 72.

Upon completion of the installation, a visual inspection and a functional acceptance test of the system will identify any part that is not working properly.

If the insurance or fire service professional witness a periodic test of an installed fire alarm system, they should review the records of previous tests and compare them with the current test results to be sure that all parts of the system continue to function properly. Periodic inspections and functional test throughout the life of the fire alarm system help determine if any part of the system as failed.

Although fire alarm systems have power supplies and the means of interconnecting the components “monitored for integrity,” the advent of solid state electronic components in these systems has introduced numerous unsupervised components and junctions that can fail without notifications of the failure. Such a failure can impair part or all of the system without any apparent change in the status of the system. Testing therefore is integral to maintaining a high level of mission effectiveness.

Inspectors should be familiar with the National Fire Alarm and Signaling Code so that during the inspection they can determine if the installer has selected the appropriate alarm initiating devices and notification appliances, and installed them in accordance with the requirements of the code.

It is recommended that the test of the entire fire alarm system be conducted as follows:

1. Test the fire alarm system control unit to verify that it is in the normal supervisory condition as detailed in the manufacturer’s instruction manual.
2. Test each initiating device circuit and notification appliance circuit to confirm that the system control unit is monitoring the integ-

rity of the installation conductors. Sequentially open, ground and short the connection at enough initiating devices and notification appliances to assure a thorough test.

3. Test each initiating device and notification appliance for operation and for proper response at the system control unit. Test all functions, including all supplementary functions, in accordance with the manufacturer's manual and NFPA 72, Chapter 14.
4. Test the primary (main) power supply and secondary (standby) power supply.
5. Test all functions of the fire alarm control unit as described in the system operational description.

If any additions or other changes are made to the fire alarm system, the inspector should witness a re-acceptance test on all affected portions. Consult with NFPA 72, Chapter 14, for the scope of such a reacceptance test. This will help assure the continued integrity of the fire alarm system.

## Testing Heat Detectors

A restorable heat detector and the restorable element of a combination detector should be tested by exposing the detector to a safe heat source (such as hot water, a hair dryer, or a shielded heat lamp) until it responds. The detector should reset automatically after each heat test. Precautions should be taken to avoid damage to the nonrestorable fixed-temperature element of a combination rate-of-rise/fixed temperature detector. Follow the testing procedures in NFPA 72, Chapter 14.

## Testing Smoke Detectors

The person testing should visually inspect each smoke detector and introduce smoke or other aerosol acceptable to the manufacturer into the

detector at its installed location to assure that smoke can enter the chamber and initiate an alarm. Some testing companies use a bee smoker as one source of relatively safe smoke. Residential smoke alarms have an integral test means that permits the homeowners to test the smoke alarm circuitry.

The 2010 edition of the National Fire Alarm and Signaling Code Chapter 14 requires the periodic test of the sensitivity of a smoke detector to assure that the sensitivity has remained within the listed and marked sensitivity on the detector. The code permits several methods of testing sensitivity, but does not permit the use of unmeasured amounts of an aerosol. In all cases, the person testing should follow the manufacturer's instructions for testing the smoke detectors.

## Testing Manual Fire Alarm Boxes

The National Fire Alarm and Signaling Code Chapter 14 specifies the testing frequency for manual fire alarm boxes. When testing, follow the manufacturer's operating instructions.

## Testing Fire Safety Function Interfaces

NFPA 72, Chapter 14 requires that all interfaced systems be tested in conjunction with, and at the same time as, the fire alarm system. This includes fan control, elevator recall, suppression system activation (depending on the type of suppression system, discharge simulation may be acceptable), automatic unlocking of exit doors, smoke door release and other similar fire safety functions.

It is imperative that the inspector requires all trades involved with any interfaced system to be present at the fire alarm system acceptance test. This will help to ensure that the control and monitoring of fire safety functions is operational and working as required by the codes and specifications.

## Testing Remote Annunciators

The function of a remote annunciator is to assist the responding fire service personnel in locating the fire source. The labeling and clarity of the annunciator layout must be approved by the people who will use it: the emergency responders! It should be remembered that complete point identification may not be necessary at the remote annunciator. Keeping the remote annunciator to simple graphics will often be more beneficial to the emergency responders. It is important also to verify that the zone or point indications at the remote annunciator are identical to those at the fire alarm control unit.

## Testing Notification Appliances

One of the weakest points in many fire alarm system designs has been the audibility of the notification appliances. NFPA 72 now requires that audibility be measure using a sound level meter. Never trust an inspector's "calibrated ear." Ensure that the ambient audibility matches the guidelines given in NFPA 72-2010, Chapter 18. The Americans with Disabilities Act (ADA) also required that the notification appliances, both audible and visible, be place throughout the facility based on the ADA Accessibility Guidelines (ADAAG). Fortunately, the National Fire Alarm and Signaling Code requirements contained in Chapter 18 has been accepted as equivalent to the ADA requirements.

## New Technology

Most new fire alarm systems are microprocessor (computer) based and will require software in addition to the hardware. The integrity of the software is extremely important. The inspector must determine from the documentation provided what "Rev. #" (Revision Number or

version) of the software has been installed. He or she must record this information and advise the owner that any software changes must be verified through compare programs or the fire alarm system will have to be reacceptance tested in accordance with NFPA 72, Chapter 14. The advantage of the new technology systems includes complete system operation documentation and, with analog systems, the ability to determine the sensitivity of connected smoke detectors from the fire alarm control unit.

Remember, the better the acceptance test, the more reliable the fire alarm system installation will be. Maybe insurance and fire service professionals find that due to personnel cutbacks, they cannot be present throughout a large fire alarm system acceptance test. That is the key reason for all of the documentation requirements. If you are in this position, it may be to your jurisdiction's benefit to require that the fire alarm system be NRTL Certificated. (Central Station Service systems must be NRTL Certificated.). As a part of the Certificate program, NRTLs require the company issuing the Certificate to hold a contract to provide testing and maintenance of the fire alarm system in accordance with the requirements of NFPA 72. The Certified testing companies will then be responsible for ensuring that all NFPA 72 and building code requirements are met. The certified companies (Central Station or Protected Premises, see Sections 3 & 4) can also issue certificate and service the fire alarm systems. This procedure will help ease the requirements for the fire service inspector to be present during all of the tests conducted.

For more information regarding these procedures or to ensure that you are using a NRTL Listed central station, refer to [www.csaaintl.org](http://www.csaaintl.org) for a complete listing of Listed central stations that are members of CSAA.

---

# References

**Fire Alarm Signaling Systems Handbook**, Second Edition, Bukowski, O’Laughlin, National Fire Protection Association, One Batterymarch Park, Quincy, MA 02269 (1994).

**Fire Alarm Systems Seminar Workbook**, Principal Author: Robert Schifiliti, P.E., with Review assistance by Wayne Moore, P.E., Jeffrey Moore, P.E., and Dean Wilson, P.E. National Fire Protection Association, One Batterymarch Park, Quincy, MA 02269 (1997).

**Fire Protection Handbook**, Eighteenth Edition. A. Cote, J. Linville, National Fire Protection Association, One Batterymarch Park, Quincy, MA 02269 (1997).

**Guide for Application of System Smoke Detectors**, National Electrical Manufacturers Association (NEMA), 1300 North 17th Street, Suite 1847, Rosslyn, VA 22209 (1997).

**NFPA 720, Standard for the Installation of Carbon Monoxide (CO) Detection and Warning Equipment**, 2009 edition.

**National Fire Alarm and Signaling Code®**, 2010 edition, National Fire Protection Association, One Batterymarch Park, Quincy, MA 02269.

**National Electrical Code**, 2009 edition, National Fire Protection Association, One Batterymarch Park, Quincy, MA 02269.

**The Moore-Wilson Signaling Report**, a bimonthly fire protection newsletter dealing with fire alarm systems, edited by Wayne D. Moore, P.E. and Dean K. Wilson, P.E. the Fire Protection Alliance, 2348 Post Road, Suite 29, Warwick, RI 02886.

**Training Manual on Fire Alarm Systems**, National Electrical Manufacturers Association (NEMA), 1300 North 17th Street, Suite 1847, Rosslyn, VA 22209 (1997).

**Fire Detection Sensors and Alarm Systems**, Handbook of Utilities and Services for Buildings. C. Harris, Editor. New York: McGraw-Hill, Chapter 38. (1990).

**Fire Protection Equipment Directory**, Underwriters Laboratories, 333 Pfingsten Road, Northbrook, IL 60062-2096. (1998).

**FMRC Approval Guide**, Factory Mutual Research Corporation, 1151 Boston-Providence Turnpike, Norwood, MA 02062 (1998).

**IRI Information**, IM.11.0.1, Industrial Risk Insurers, 85 Woodland Street, Hartford, CT. (1998).

**How Reliable Is Your Fire Alarm System?** John M. Cholin, P.E. Wayne D. Moore, P.E., NFPA Journal Volume 89/Number 1, January/February 1995.

**Design of Special Hazard & Fire Alarm Systems**, Robert M. Gagnon, Delmar Publishers, 3 Columbia Circle, Albany, NY 12212-5015 (1998).

---

## Appendix – Glossary of Terms

**Acknowledge.** To confirm that a message or signal has been received, such as by the pressing of a button or the selection of a software command.

**Active Multiplex System.** A multiplexing system in which signaling devices such as transponders are employed to transmit status signals of each initiating device or initiating device circuit within a prescribed time interval so that lack of receipt of such signal may be interpreted as a trouble signal.

**Addressable Device.** A fire alarm system component with discrete identification that can have its status individually identified or that is used to individually control other functions.

**Adverse Condition.** Any condition occurring in a communications or transmission channel that interferes with the proper transmission or interpretation, or both, of status change signals at the supervising station. (*See also Trouble Signal*)

**Air Sampling-Type Detector.** A detector that consists of a piping or tubing distribution network from the detector to the area (s) to be protected. An aspiration fan in the detector housing draws air from the protected area back to the detector through air sampling ports, piping, or tubing. At the detector, the air is analyzed for fire products.

**Alarm Initiating Device.** A device which, when actuated initiates an alarm. Such devices, depending on their type, can be operated manually or actuated automatically in response to smoke, flame, heat, or water flow.

**Alarm Signal.** A signal indicating an emergency requiring immediate action, such as an alarm for fire from a manual station, a water flow alarm, or an alarm from an automatic fire alarm system.

**Alarm System.** A combination of compatible initiating devices, control panels, and notification appliances designed and installed to produce an alarm signal in the event of fire.

**Alarm Verification Feature.** A feature of automatic fire detection and alarm systems to reduce unwanted alarms wherein automatic smoke detectors must report alarm conditions for a minimum period of time, or confirm alarm conditions within a given period of time after being reset, to be accepted as a valid alarm initiation signal.

**Alert Tone.** An attention-getting signal to alert occupants of the pending transmission of a voice message.

**Analog Initiating Device (Sensor).** An initiating device that transmits a signal indicating varying degrees of condition as contrasted with a conventional initiating device, which can only indicate an on/off condition.

**Annunciator.** A unit containing two or more indicator lamps, alphanumeric displays, or other equivalent means in which each indication identifies the circuit, or location to be annunciated.

**Approved.** Acceptable to the authority having jurisdiction.

**Authority Having Jurisdiction.** The organization, office, or individual responsible for approving equipment, an installation, or a procedure.

NFPA 72 contains an appendix item commenting on the definition for “Authority Having Jurisdiction” as follows:

**A-1-4 Authority Having Jurisdiction.** The phrase “authority having jurisdiction” is used in NFPA documents in a broad manner, since jurisdictions and approval agencies vary, as do their responsibilities. Where public safety is primary, the authority having jurisdiction may be a federal, state, local or other regional department or individual such as a fire chief; fire marshal; chief of a fire prevention bureau, labor department, or health department; building official; electrical inspector; or others having statutory authority. For insurance purposes, an insurance inspection department, rating bureau, or other insurance company representative may be the authority having jurisdiction. In many circumstances, the property owner or his or her designated agent assumes the role of the authority having jurisdiction; at government installations, the commanding officer or departmental official may be the authority having jurisdiction.

**Auxiliary Fire Alarm System.** A connection to the municipal fire alarm system to transmit an alarm of fire to the municipal communications center. Fire alarms from an auxiliary alarm system are received at the municipal communications center on the same equipment and by the same alerting methods as alarms transmitted by municipal fire alarm boxes located on streets.

**Average Ambient Sound Level.** The root mean square, A-weighted sound pressure level measured over a 24-hour period.

**Bell.** A single stroke or vibrating type audible notification appliance which has a bell tone.

**Box, Fire Alarm.** (Also see “manual fire alarm box”)

- a. **Noncoded.** A manually operated device which, when operated, closes or opens one or more sets of contacts and generally locks the contacts in the operated position until the box is reset.
- b. **Coded.** A manually operated device in which the act of pulling a lever causes the transmission of not less than three rounds of coded alarm signals. Similar to the non-coded type, except that instead of a manually operated switch, a mechanism to rotate a code wheel is utilized. Rotation of the code wheel, in turn, causes an electrical circuit to be alternately opened and closed, or closed and opened, thus transmitting a coded alarm signal which identifies the location of the box. The code wheel is cut for the individual code to be transmitted by the device and can operate by clockwork or an electric motor. Clockwork transmitters can be pre-wound or can be wound by the pulling of the alarm lever. Usually the box is designed to repeat its code four times and automatically come to rest. Pre-wound transmitters must sound a trouble signal when they require rewinding. Solid state, electronic coding devices are also used in conjunction with the fire alarm control unit to produce a coded sounding of the system’s audible notification appliances.

**Breakglass Fire Alarm Box.** A fire alarm box in which it is necessary to break a special element in order to operate the box.

**Ceiling.** The upper surface of a space, regardless of height. Areas with a suspended ceiling would have two ceilings, one visible from the floor and the one above the suspended ceiling.

**Ceiling Height.** The height from the continuous floor of a room to the continuous ceiling of a room or space.

**Ceiling-Surfaces.** Ceiling surfaces referred to in conjunction with the locations of initiating devices are defined as follows:

**Beam Construction.** Ceilings having solid structural or solid nonstructural members projecting down from the ceiling surface more than 4 in. (100 mm) and spaced more than 36 in. (910 mm), center to center.

**Girder.** A support for beams or joists that runs at right angles to the beams or joists. If the top of girders is within 4 in. (100 mm) of the ceiling, the girder is a factor in determining the number of detectors and is to be considered a beam. If the top of the girder is more than 4 in. (100 mm) from the ceiling, the girder is not a factor in detector location.

**Solid Joist Construction.** Ceilings that have solid structural or solid nonstructural members projecting down from the ceiling surface for a distance of more than 4 in. (100mm) and spaced at intervals of 36 in (910 mm) or less, center to center.

**Central Station.** A supervising station that is listed for central station service.

**Central Station Fire Alarm System.** A system or group of systems in which the operations of circuits and devices are transmitted automatically to, recorded in, maintained by, and supervised from a listed central station having competent and experienced servers and operators who, upon receipt of a signal, take such action as required by this code. Such service is to be controlled and operated by a person, firm, or corporation whose business is the furnishing, maintaining, or monitoring of supervised fire alarm systems.

**Central Station Service.** The use of a system or a group of systems in which the operations of circuits and devices at a protected property are

signaled to, recorded in, and supervised from a listed central station having competent and experienced operators who, upon receipt of a signal, take such action as required by this code. Related activities at the protected property such as equipment installation, inspection, testing, maintenance, and runner service are the responsibility of the central station or a listed fire alarm service local company. Central station service is controlled and operated by a person, firm, or corporation whose business is the furnishing of such contracted services or whose properties are the protected premises.

**Certification.** A systematic program using randomly selected follow-up inspections of the Certificated systems installed under the program, which allows the listing organization to verify that a fire alarm system complies with all the requirements of this code. A system installed under such a program is identified by the issuance of a certificate and is designated as a certificated system.

**CFM.** Unit volume of flow of a gaseous substance (such as air) measured in cubic feet per minute.

**Chime.** A single-stroke or vibrating type audible notification appliance which has a xylophone-type striking bar and / or tone.

**Circuit Interface.** A circuit component that interfaces initiating devices or control circuits, or both, notification appliances or circuits, or both, system control outputs, and other signaling line circuits to a signaling line circuit.

**Coded.** An audible or visible signal conveying several discrete bits or units of information. Notification signal examples are numbered strokes of an impact-type appliance and numbered flashes of a visible appliance.

**Combination Detector.** A device that either (a) responds to more than one of the fire signatures or (b) employs more than one operating principle to sense any one of these signatures. Typical examples are (a) combination of a heat detector with a smoke detector, or (b) a combination rate-of-rise and fixed temperature heat detector.

**Combination Fire Alarm and Guard's Tour Box.** A manually operated box for separately transmitting a fire alarm signal and a distinctive guard patrol tour supervisory signal.

**Combination System.** A protected premises fire alarm system for fire alarm, supervisory or watchman service whose components can be used in whole or part in common with a non-fire-emergency signaling system, such as a paging system, a musical program system, HVAC control system, or a process monitoring system, without degradation of, or hazard to, the fire alarm system.

**Control Unit.** A device with the control circuits necessary to (1) furnish power to a fire alarm system; (2) receive signals from alarm initiating devices and transmit them to audible indicating appliances and accessory equipment; and (3) monitor the integrity of the system installation wiring and primary (main) power. The control unit can be contained in one or more cabinets in adjacent or remote locations.

**Communications Channel.** A circuit or path connecting a subsidiary station (s) to a supervising station (s) over which signals are carried.

**Compatibility Listed.** A specific listing process that applies only to two-wire devices (such as smoke detectors) that are designed to operate with certain control equipment.

**Compatible (Equipment).** Equipment that interfaces mechanically or electrically together as manufactured and without field modification.

**Contiguous Property.** A single-owner or single-user protected premises on a continuous plot of ground, including any buildings thereon, that is not separated by a public thoroughfare, transportation right-of-way, property owned or used by others, or body of water not under the same ownership.

**Damper.** A valve or plate regulating the flow of air or other fluid.

**Digital Alarm Communicator Receiver (DACR).** A system component located in the supervising station that will accept and display signals from the DACT's sent over the public switched telephone system.

**Digital Alarm Communicator System (DACS).** A system in which signals are transmitted from a Digital Alarm Communicator Transmitter (DACT) located at the protected premises through the public switched telephone network to a Digital Alarm Communicator Receiver (DACR) located at the supervising station.

**Digital Alarm Communicator Transmitter (DACT).** A system component at the protected premises to which initiating devices or groups of devices are connected. The DACT will seize the connected telephone line, dial a preselected number to connect to a DACR in the supervising station, and transmit signals indicating a status change of the initiating device.

**Duct.** A passageway made of sheet metal or other suitable material not necessarily leak-tight, used for conveying air or other gas at low pressures.

**Duct Smoke Detector.** A device located within a duct, protruding into a duct, or located outside a duct that will detect visible or invisible particles of combustion flowing within the duct. Actuation of the device may allow operation of certain control functions.

**End of Line Device.** A device such as a resistor or diode placed at the end of a circuit to maintain monitoring fire integrity.

**End of Line Relay.** Device used to supervise power (usually for four wire smoke detectors) and installed within or near the last device on the circuit.

**Four Wire Smoke Detector.** A smoke detector which initiates an alarm condition on a circuit separate from the circuit that supplies operating power to the device.

**General Alarm.** A term usually applied to the simultaneous operation of all the audible and visible alarm notification appliances on a system to indicate the need for evacuation of a building.

**Heat Detector.** A device that detects abnormally high temperature or rate-of-temperature rise.

**Initiating Device Circuit.** A circuit to which automatic or manual signal initiating devices are connected where the signal received does not normally identify the individual device operated.

**Ionization Smoke Detector.** An ionization smoke detector has a small amount of radioactive material which ionizes the air in the sensing chamber, thus rendering it conductive and permitting a current to flow between two charged electrodes. This gives the sensing chamber an effective electrical conductance. When smoke particles enter the sensing chamber, they decrease the conductance. When the conductance is less than a predetermined level, the detector actuates.

**IP.** Internet Protocol or packet data.

**Labeled.** Equipment or materials to which has been attached a label, symbol, or other identifying mark of an organization acceptable to the authority having jurisdiction and concerned with product evaluation, that maintains periodic inspection of the production of such labeled equipment or materials and by whose labeling the manufacturer indicates compliance with appropriate standards or performance in a specified manner.

**Light Scattering.** The action of light being reflected and/or refracted off particles of combustion, as in a light scattering photoelectric smoke detector.

**Listed.** Equipment or materials included in a list published by an organization acceptable to the authority having jurisdiction and concerned with evaluation of products and services, that maintains periodic inspection of listed equipment or materials or periodic evaluation of services and whose listing states either that the equipment, material or service meets identified standards or has been tested and found suitable for a specified purpose.

**Managed Facilities-Based Voice Network (MFVN).** A physical facilities-based network capable of transmitting real time signals with formats unchanged that is managed, operated, and maintained by the service provider to ensure service quality and reliability from the subscriber location to public switched telephone network (PSTN) interconnection points or other MFVN peer networks.

**Monitoring for Integrity.** The ability to detect a fault condition in the installation wiring which would prevent normal operation of the fire alarm system.

**National Fire Protection Association (NFPA).**

NFPA administers the development of and published codes, standards, and other materials concerning all phases of fire safety.

**Notification Appliance.** A fire alarm system component such as a bell, horn, speaker, light, or text display that provides audible, tactile, or visible outputs, or any combination thereof.

**Audible Notification Appliance.** A notification appliance that alerts by the sense of hearing.

**Audible Textual Notification Appliance.** A notification appliance that conveys a stream of audible information. An example of an audible textual appliance is a speaker that reproduces a voice message.

**Olfactory Notification Appliance.** A notification appliance that alerts by the sense of smell.

**Tactile Notification Appliance.** A notification appliance that alerts by the sense of touch or vibration.

**Visible Notification Appliance.** A notification appliance that alerts by the sense of sight.

**Visible Textual Notification Appliance.** A notification appliance that conveys a stream of visible information. An example of a visible textual appliance is a screen or monitor that displays an alphanumeric or pictorial message.

**Notification Appliance Circuit.** A circuit or path directly connected to a notification appliance(s).

**Notification Zone.** An area covered by notification appliances that are activated simultaneously.

**NRTL.** National Recognized Testing laboratory, such as Underwriters Laboratories, FMRC and Intertek.

**Nuisance Alarm.** Any alarm caused by mechanical failure, malfunction, improper installation, or lack of proper maintenance, or any alarm activated by a cause that cannot be determined.

**Operating Mode, Private.** Audible or visible signaling only to those persons directly concerned with the implementation and direction of emergency action in the area protected by the fire alarm system.

**Operating Mode, Public.** Audible or visible signaling to occupants or inhabitants of the area protected by the fire alarm system.

**Photoelectric Smoke Detector.** In the photoelectric light scattering smoke detector, a light source and a photosensitive sensor are so arranged that the rays from the light source do not normally fall on the photosensitive sensor. When smoke particles enter the light path, some of the light is scattered by reflection and refraction onto the sensor, causing the sensor to respond.

**Projected Beam (Smoke) Detector.** In a projected beam photoelectric smoke detector, the amount of light transmitted between a light source and a photosensitive sensor is monitored. When smoke particles are introduced in the light path, some of the light is scattered and some absorbed, thereby reducing the light reaching the receiver, causing the detector to respond.

**Protected Premises Fire Alarm System.** A system that sounds an alarm at the protected premises as the result of the manual operation of a fire alarm box or the operation of protection equipment or systems such as water flowing in a sprinkler system, the discharge of carbon dioxide or Halon 1301, or the detection of smoke, heat or flame.

**Public Switched Telephone Network (PSTN).** An assembly of communications equipment and telephone service providers that utilize managed facilities-based voice networks (MFVN) to provide the general public with the ability to establish communications channels via discrete dialing codes.

**Rate-of-Rise Heat Detector.** A device which will respond when the temperature rises at a rate exceeding a predetermined amount.

**Remote Supervising Station Fire Alarm System.** A system that connects alarm initiating devices or a control unit in a protected premises to signal receiving equipment at a Remote Supervising Station, such as fire or police headquarters or other places acceptable to the authority having jurisdiction.

**Spot Detector.** A device whose detecting element is concentrated at a particular location. Typical examples are bimetallic detectors, fusible alloy detectors, certain pneumatic rate-of-rise detectors, certain smoke detectors and thermo-electric effect detectors.

**Stratification.** An effect that occurs when heated air containing smoke particles or gaseous combustion products rises until it reaches a level at which there is no longer a difference in temperature between it and the surrounding air. Stratification can also be caused by powered ventilation that develops an opposing airflow.

**Supervisory Signal.** A signal indicating the need for action in connection with the supervision of guard tours, automatic sprinkler or other extinguishing systems or equipment, or the maintenance features of other protective systems.

**Thermal Lag.** The time it takes for the operating element of a heat detector to absorb heat from the surrounding air. Thus, when a fixed temperature device operates, the temperature of the surrounding air will always be higher than the operating temperature of the device itself.

**Trouble Signal.** An audible signal indicating trouble of any nature, such as a circuit open or ground occurring in the device or wiring, or with a power supply associated with a fire alarm system.

**Two-Wire Smoke Detector.** A smoke detector which initiates an alarm condition on the same circuit that also supply power to the detector.

**Waterflow Switch.** A listed so constructed and installed that any flow of water from a sprinkler system equal to or greater than that from a single automatic sprinkler head will result in actuation of this switch and subsequently indicate an alarm condition.

**Zone.** A designated area of a building. Commonly, zones within a building are annunciated remotely to enable the emergency responders to rapidly locate a fire. The term can also indicate an area served by detectors.